

KAJ[®]
kajworld.com
Email : info@kajworld.com

Solid Top Manhole Covers, Sewer Cover, Drainage Cover, Telecom Cover, Earth Pit Cover, Recessed Cover, Iron Gratings, Channel Gratings, Square Gratings, Catch Basin, Tree Gratings, Hydrant Cover, Kerb Gullies

OUR PLANT



KAJ[®]

kajworld.com

Email : info@kajworld.com

DUCTILE IRON • CAST IRON

Solid Top Manhole Covers, Sewer Cover, Drainage Cover, Telecom Cover, Earth Pit Cover, Recessed Cover, Iron Gratings, Channel Gratings, Square Gratings, Catch Basin, Tree Gratings, Hydrant Cover, Kerb Gullies



Email : info@kajworld.com

kajworld.com

+91 98300 60210 INDIA +91 9088866000 INDIA
+971 52 831 3848 DUBAI +971 52 186 7876 DUBAI

KOLKATA Address : 74A, CHARU AVENUE, KOLKATA - 700 033

UAE Address : Plot Number : 619-0 Building Name : ABRAJ Center, Naif Street - Dubai

KAJ[®]

kajworld.com
Email : info@kajworld.com

+91 9830060210
+91 9088866000
+971 52 831 3848 DUBAI

Solid Top Manhole Covers, Sewer Cover, Drainage Cover, Telecom Cover, Earth Pit Cover, Recessed Cover, Iron Gratings, Channel Gratings, Square Gratings, Catch Basin, Tree Gratings, Hydrant Cover, Kerb Gullies

KAJ[®]

kajworld.com
Email : info@kajworld.com
KAJ[®] Roof Drain



KAJ[®] Ductile Iron Manhole Cover



KAJ[®] FRP Manhole Cover

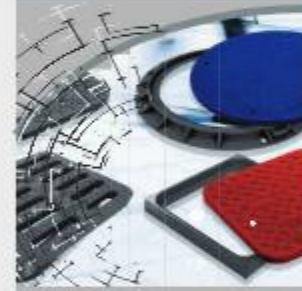

KAJ[®] Stainless Steel Floor Drain



KAJ[®] Hinged Solid Top Manhole Cover

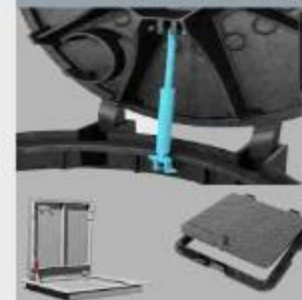

KAJ[®] Cast Iron Manhole Cover

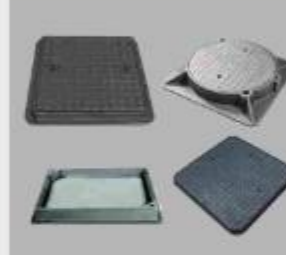

KAJ[®] Catch Manhole Cover

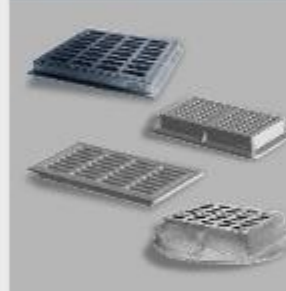

KAJ[®] Water tight Air tight Manhole Cover

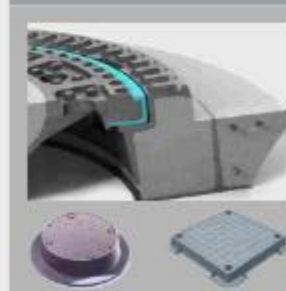

KAJ[®] CHANNEL GRATING



KAJ[®] Aluminum Manhole Cover



KAJ[®] Surface Box



KAJ[®] Steel Gratings



KAJ[®] Foot Step



CONTENTS

- Product Range
- India Certificates
- Dubai Certificates
- Duty Towards Our Environment
- About Us
- History of Manhole Cover
- Standard Classification
- Infrastructure & Facilities
- Production Flowchart
- Installation Process
- Factory Visit
- Little About BSI
- KAJ Non - Kite mark Range
- KAJ Kite mark Range
- KAJ Europe Range
- KAJ Accessories Seal Plate & Lift Key
- Foot Step
- Glossary

Trade Mark Certificate in India

प्रारूप आरजी - 2
Form RG - 2



भारत सरकार
Government of India
व्यापार चिन्ह रजिस्ट्री
Trade Mark Registry
व्यापार चिन्ह अधिनियम, 1999
Trade Marks Act, 1999

व्यापार चिन्ह के रजिस्ट्रेशन का प्रमाणपत्र, धारा 23 (2), नियम 56 (1)
Certificate of Registration of Trade Mark, Section 23 (2), Rule 56 (1)

क्रमांक
No. 3140680

व्यापार चिन्ह संख्या / Trade Mark No. 4998778

दिनांक /Date 09/06/2021

अ. संख्या /J. No. 2065

यह प्रमाणित किया जाता है कि जिस प्रकार चिन्ह की समाकृति इसके साथ संलग्न है, वह नाम से रजिस्ट्रीकृत हो चुका है।
 Certified that Trade Mark / a representation is annexed hereto, has been registered in the name(s) of:-
 KAJ BUILDING MATERIAL PRIVATE LIMITED, 74A, CHARU CHANDRA AVENUE, KOLKATA, PIN - 700033, PRIVATE LIMITED, (Body Incorporate)

In Class 6

Under No. 4998778

as of the date 09 June 2021

in respect of

MANUFACTURER OF BUILDING MATERIAL & CONSTRUCTION ENGINEERING PRODUCTS AS INCLUDED IN CLASS 6.

मेरे निर्देश पर आज के मास के वे दिन को इस पर मुद्रा लगायी गई

Sealed at my direction, this 31st day of December, 2022

Trade Mark No. 4998778
Annexure of Certificate No. : 3140680
Date 09/06/2021

KAJ

IN CHAPTER CLASS 6 SCHEDULE
Bolt Top Manhole Covers, Sewer Cover, Drainage Cover, Telecom Cover, Earth Pit Cover, Recessed Cover, Iron Gratings, Channel Gratings, Square Gratings, Catch Basin, Tree Gratings, Hydrant Cover, Kerb Gullies.



व्यापार चिन्ह रजिस्ट्री
Registrar of Trademarks

रजिस्ट्रेशन प्रमाण की अवधि 10 वर्ष के लिए है और प्रत्येक 10 वर्ष की अवधि के लिए और प्रत्येक 10 वर्ष की अवधि के अन्त में भी नवीनीकृत किया जा सकता है।
 Registration is for 10 years from the date of application and it then be renewed for a period of 10 years and also at the expiration of each period of 10 years.

यह प्रमाणपत्र सिर्फ कानूनी प्रयोजनों के लिए ही उपयोग में रजिस्ट्रेशन अधिनियम के अंतर्गत है।
 This certificate is not for use in legal proceedings or for obtaining Registration abroad.

टिप्पणी: इस व्यापार चिन्ह के स्वामित्व में कोई परिवर्तन होने पर, या कारोबार के मुख्य स्थान के पते में या भारत में लक्ष्य के लिए को में परिवर्तन होने पर परिवर्तन के लिए अर्जन तुरंत किया जाना चाहिए।
 Note: Upon any change of ownership of this Trademark, or change in address, of the principal place of business or address for service in India a request should AT ONCE be made to register the change.

02

03

Certificates of Approval in India

Certificates of Approval in India

Certificate of Registration

This is to Certify That
Quality Management System of

KAJ®

KAJ BUILDING MATERIAL PRIVATE LIMITED
REGD. OFFICE : 74A CHARU AVENUE, KOLKATA - 700 033, INDIA
FACTORY : PLOT 27/A/P, WBIDC GROWTH CENTER,
ULUBERIA, HOWRAH, WEST BENGAL, 711316, INDIA

has been assessed and found to conform to the requirements of
ISO 9001:2015
for the following scope :

Solid Top Manhole Covers, Sewer Cover, Drainage Cover,
Telecom Cover, Earth Pit Cover, Recessed Cover, Iron Gratings,
Channel Gratings, Square Gratings, Catch Basin,
Tree Gratings, Hydrant Cover, Kerb Gullies,

Certificate No : **24MEQTPB3**
Initial Registration Date : 19/10/2024 Issuance Date : 19/10/2024
Date of Expiry : 18/10/2027
1st Surve. Due : 19/09/2025 2nd Surve. Due : 19/09/2026

ISO 9001:2015

Director
Magnitude Management Services Pvt. Ltd.

Certificate of Registration

This is to Certify That
Environmental Management System of

KAJ®

KAJ BUILDING MATERIAL PRIVATE LIMITED
REGD. OFFICE : 74A CHARU AVENUE, KOLKATA - 700 033, INDIA
FACTORY : PLOT 27/A/P, WBIDC GROWTH CENTER,
ULUBERIA, HOWRAH, WEST BENGAL, 711316, INDIA

has been assessed and found to conform to the requirements of
ISO 14001:2015
for the following scope :

Solid Top Manhole Covers, Sewer Cover, Drainage Cover,
Telecom Cover, Earth Pit Cover, Recessed Cover, Iron Gratings,
Channel Gratings, Square Gratings, Catch Basin,
Tree Gratings, Hydrant Cover, Kerb Gullies,

Certificate No : **24MEETV01**
Initial Registration Date : 19/10/2024 Issuance Date : 19/10/2024
Date of Expiry : 18/10/2027
1st Surve. Due : 19/09/2025 2nd Surve. Due : 19/09/2026

ISO 14001:2015

Director
Magnitude Management Services Pvt. Ltd.

UDYAM REGISTRATION CERTIFICATE

UDYAM REGISTRATION NUMBER : **UDYAM-WB-10-4131799**

NAME OF ENTERPRISE : **KAJ BUILDING MATERIAL PRIVATE LIMITED**

TYPE OF ENTERPRISE :

S.No.	Classification Year	Enterprise Type	Classification Date
1	2024-25	Micro	19/09/2024

MAJOR ACTIVITY : **MANUFACTURING**

SOCIAL CATEGORY OF ENTREPRENEUR : **GENERAL**

NAME OF UNIT(S) :

S.No.	Name of Unit(s)
1	KAJ BUILDING MATERIAL PRIVATE LIMITED

OPTICAL ADDRESS OF ENTERPRISE :

Plot/Block/Trunk No.	Taluk	Name of Panchayat/Block	Area/Block
Village/Town	Kolkata	Block	1
House/Street/Line	Charu Avenue	City	Kolkata
State	WEST BENGAL	District	KOLKATA, WB 700033
Mobile	9880689800	Landline	(Optional) 9880689800

DATE OF INCORPORATION / REGISTRATION OF ENTERPRISE : **06/02/2024**

DATE OF COMMENCEMENT OF PRODUCTION/BUSINESS : **06/04/2024**

NATIONAL INDUSTRY CLASSIFICATION CODE(S) :

S.No.	NIC 2 Digit	NIC 4 Digit	NIC 5 Digit	Activity
1	25	2511	25119	Manufacture of other iron and steel casting and products thereof

DATE OF UDYAM REGISTRATION : **19/09/2024**

* In case of production (export/import) of status of an enterprise, the benefit of the Government Subsidies will be credited as per the provisions of Notification No. S.12, 10/19/1 dated 28.06.2009 issued by the MoS, GOI.

Disclaimer: This is a system generated document, no signature required. Printed from udyamregistration.gov.in & Date of printing: 19/09/2024

KAJ® Ministry Of Corporate Affairs
Government of India / भारत सरकार
Date : 16-10-2024 3:50:58 pm

Company Information

CIN	U25110WB2004PTC200163
Company Name	KAJ BUILDING MATERIAL PRIVATE LIMITED
ROC Name	ROC Kolkata
Registration Number	268163
Date of Incorporation	06/02/2024
Email Id	kajbuilding@gmail.com
Registered Address	74A, CHARU CHANDRA AVENUE, Tollygunge, Kolkata, Kolkata, West Bengal, India, 700033
Address at which the books of account are to be maintained	-
Listed in Stock Exchange(s) (Y/N)	No
Category of Company	Company limited by shares
Subcategory of the Company	Non-government company
Class of Company	Private
ACTIVE compliance	-
Authorised Capital (Rs)	10,00,000
Paid up Capital (Rs)	1,00,000
Date of last AGM	-
Date of Balance Sheet	-
Company Status	Active

Jurisdiction : **ROC Kolkata**

Certificate of Registration

This is to Certify That
Occupational Health & Safety Management System of

KAJ®

KAJ BUILDING MATERIAL PRIVATE LIMITED
REGD. OFFICE : 74A CHARU AVENUE, KOLKATA - 700 033, INDIA
FACTORY : PLOT 27/A/P, WBIDC GROWTH CENTER,
ULUBERIA, HOWRAH, WEST BENGAL, 711316, INDIA

has been assessed and found to conform to the requirements of
ISO 45001:2018
for the following scope :

Solid Top Manhole Covers, Sewer Cover, Drainage Cover,
Telecom Cover, Earth Pit Cover, Recessed Cover, Iron Gratings,
Channel Gratings, Square Gratings, Catch Basin,
Tree Gratings, Hydrant Cover, Kerb Gullies,

Certificate No : **24MEOTA#1**
Initial Registration Date : 19/10/2024 Issuance Date : 19/10/2024
Date of Expiry : 18/10/2027
1st Surve. Due : 19/09/2025 2nd Surve. Due : 19/09/2026

ISO 45001:2018

Director
Magnitude Management Services Pvt. Ltd.

GOVERNMENT OF INDIA
MINISTRY OF CORPORATE AFFAIRS
Central Registration Centre
Certificate of Incorporation

(Pursuant to sub-section (2) of section 7 and sub-section (1) of section 8 of the Companies Act, 2013 (18 of 2013) and rule 16 of the Companies (Incorporation) Rules, 2014)

I hereby certify that KAJ BUILDING MATERIAL PRIVATE LIMITED is incorporated on the SIXTH day of FEBRUARY TWO THOUSAND TWENTY FOUR under the Companies Act, 2013 (18 of 2013) and that the company is Company limited by shares.

The Corporate Identity Number of the company is **U25110WB2004PTC200163**
The Permanent Account Number (PAN) of the company is **AAKCK8021C**
The Tax Deduction and Collection Account Number (TAN) of the company is **GALH1983A***

Given under my hand at Kolkata on the SIXTH day of FEBRUARY TWO THOUSAND TWENTY FOUR.

Vasanthini Niguzan
Assistant Registrar of Companies/ Deputy Registrar of Companies/ Registrar of Companies
For and on behalf of the Jurisdictional Registrar of Companies
Central Registration Centre

Disclaimer: This certificate only evidences incorporation of the company on the basis of statements and declarations of the applicant(s). This certificate is neither a licence nor permission to conduct business or collect deposits or funds from public. Particulars of member register is necessary and/or required. Registration status and other details of the company can be verified on MCA21.GOV.IN.
Mailing Address can get record available in Registrar of Companies office.
KAJ BUILDING MATERIAL PRIVATE LIMITED
74A Charu Avenue, Tollygunge, Kolkata, Kolkata - 700033, West Bengal
*As issued by Income Tax Department

Government of India / भारत सरकार
Ministry of Commerce and Industry / भारत सरकार के मंत्रालय
Directorate General of Foreign Trade / निदेशक जनरल फॉरेन ट्रेड
Office of the Additional Director General of Foreign Trade, Kolkata zone office, 99B, 99C & 99D, 4, Eklakhanda Park, KOLKATA, WEST BENGAL, 700009 / A, 99B, 99C & 99D, 4, Eklakhanda Park, KOLKATA, WEST BENGAL, 700009

Import-Export Code

This is to certify that KAJ BUILDING MATERIAL PRIVATE LIMITED is issued an Import-Export Code (IEC) **AAKCK8021C** with details as follows -

IEC	AAKCK8021C
पंजीकृत नाम (PAN)	AAKCK8021C
फर्म का नाम (Firm Name)	KAJ BUILDING MATERIAL PRIVATE LIMITED
फर्म का प्रकार (Nature of Concern)	Private Limited
फर्म का स्थापना का तिथि (Date of Incorporation)	29/10/2024
पंजीकृत पता (Registered Address)	3RD FLOOR, 74A, AACHAL APARTMENT, CHARU CHANDRA AVENUE, Kolkata, West Bengal, KOLKATA, KOLKATA, WEST BENGAL, 700033
सह-संस्थापक / नामों के साक्षरता (Director / Partner Details)	Rudraje Mukherjee
डायरेक्टर / पार्टनर डिटेल्स (Director / Partner Details)	Refer online at https://dgtf.gov.in or scan the QR Code
ब्रांच डिटेल्स (Branch Details)	Refer online at https://dgtf.gov.in or scan the QR Code

Last Modified : 20/10/2024
File Number : KOLIECPAPPV90023445AM35

Note : This is a system generated certificate. Authenticity / Updated details of the IEC can be checked at verified DGT website <https://dgtf.gov.in> by entering the IEC and Firm Name under Services - View Any

Government of India
Form GST REG-06
(See Rule 10(7))
Registration Certificate
Registration Number : **19AAKCK8021C1ZM**

1. Legal Name	KAJ BUILDING MATERIAL PRIVATE LIMITED
2. Trade Name, if any	KAJ BUILDING MATERIAL PRIVATE LIMITED
3. Additional trade names, if any	
4. Constitution of Business	Private Limited Company
5. Address of Principal Place of Business	Plot No. 1, 5th Building No./Flat No. : 74A, Name Of Premises/Building: Aachal Apartment, Road/Street: CHARU AVENUE, Nearest Landmark: Sayantanayan Midstara Ghoshar, Locality/Sub Locality: Tollygunge, City/Town/Village: Kolkata District: Kolkata State: West Bengal PIN Code: 700033
6. Date of Liability	
7. Date of Validity	From 05/04/2024 To Indefinite
8. Type of Registration	Regular
9. Particulars of Approving Authority	

Signature

Name :
Designation :
Jurisdictional Office :
Date of Issue of Certificate : 21/10/2024

Note: The registration certificate is required to be prominently displayed at all places of Business/Office in the State.
This is a system generated digitally signed Registration Certificate issued based on the deemed approval of application on 21/10/2024.

Certificates of Approval in UAE

The grid contains the following certificates:

- Membership Certificate:** Issued by the Ministry of Economy, dated 2025/03/24.
- Commercial License:** Issued by DUBAI, dated 2025/03/24.
- Import and Export License:** Issued by the Ministry of Economy, dated 2025/03/24.
- Registration Certificate:** Issued by the Ministry of Economy, dated 2025/03/24.
- eEstablishment Card:** Issued by the Ministry of Economy, dated 2025/03/24.
- Trade License:** Issued by the Ministry of Economy, dated 2025/03/24.
- Registration Certificate:** Issued by the Ministry of Agriculture, dated 2025/03/24.
- Warehouse Permit:** Issued by the Ministry of Agriculture, dated 2025/03/24.
- Registration Certificate:** Issued by the Ministry of Agriculture, dated 2025/03/24.

Trade Mark Certificate in UAE



UNITED ARAB EMIRATES
MINISTRY OF ECONOMY

الإمارات العربية المتحدة
وزارة الاقتصاد

إدارة العلامات التجارية

Trade Marks Department

شهادة تسجيل علامة تجارية

عملاً بأحكام المادة 17 من مرسوم اتحادي رقم (36) لسنة 2021، بشأن العلامات التجارية تشهد وزارة الاقتصاد أن العلامة التجارية التي سبق تقديم طلب تسجيلها تحت رقم : 446319 بتاريخ : 2025/03/24

من قبل : تهابس رودرا بهوميك بينود رودرا بهوميك
الموطن :
.. اسم الشركة: شركة كاج لتجارة مواد البناء بالجملة ذ.م.م

صورة العلامة

KAJ

اسم العلامة : KAJ
رقم الفئة : 7 (بيان المنتجات موضح خلف الصفحة)
بيانات الأولوية : رقم طلب الأولوية : تاريخ الطلب : الجنسية :
قد تم تسجيلها بتاريخ : 2025/05/22

وسيطل التسجيل نافذ المفعول لمدة 10 عشر سنوات اعتباراً من 2025/03/24 وينتهي في : 2035/03/24
ويجوز تجديد الحماية وفقاً لأحكام المادة 21 من مرسوم اتحادي رقم (36) لسنة 2021، بشأن العلامات التجارية لمدد متتالية أخرى كل منها عشر سنوات.
الإشتراطات :

مدير إدارة العلامات التجارية



تحريراً في : 2025/05/22

بيان المنتجات الخاص بالعلامة المودعة تحت رقم 446319

الفئة : 7 - آلات وعدد آلية، محركات ومكائن (عدا ما كان منها للمركبات البرية) ، قارنات آلية وعناصر نقل الحركة (عدا ما كان منها للمركبات البرية) ، معدات زراعية (عدا ما يدار باليد) ، أجهزة تفتيش البيض؛ آلات بيع أوتوماتية.

Environmentally Friendly



KAJ's commitment to the environment begins with its products: their castings are made with a substantial 82% recycled content, and their foundries adhere to the strictest environmental regulations globally.



Environmentally Friendly Practices

Continuous Environmental Improvement

The company is dedicated to constantly improving its environmental impact through several key initiatives:

Recycling Scrap Metal: They annually recycle thousands of tons of scrap metals that would otherwise end up in landfills, transforming them into functional infrastructure products.

Air Quality Compliance: Their foundries comply with the EPA's Maximum Achievable Control Technology Standards (MACT)*, which involves rigorous stack testing and reporting on air pollution control systems.

Energy and Sand Reclamation: They capture and **reuse heated air** from the melting process and daily **reclaim over 90%** of their green sand.

By-Product Reuse (Slag): They responsibly use by-products from the melting process, notably "Slag." This substance, also known as "Calcium Stabilizer" for its high calcium content, is reused by other industries to replace fine aggregates in products like concrete and asphalt, and by road commissions for sanding during winter.

Tire Recycling in Products: The majority of their INFRA-RISER® rubber composite risers are made from recycled tires (92% recycled content). This product also offers an environmental benefit by reducing stormwater infiltration into sewer systems.

Waterway Protection: They use cast-in messaging on their products that read "DUMP NO WASTE! DRAINS TO WATERWAYS" to serve as a permanent reminder to the public not to pollute water sources.



*Post consumer and post industrial scrap metals are recycled into castings that build **YOUR** infrastructure.*



In essence, post-consumer and post-industrial scrap metals are the core materials for their castings, which are used to build essential infrastructure.

A Shared Commitment to the Environment

The company views environmental protection as a personal priority. They understand that, like their customers, people want to enjoy ***clean air, safe water, and a healthy environment.** Therefore, the company is fully committed to operating in complete adherence to all **environmental laws and regulations.**

This decision, calculated using the Environmental Defence Paper Calculator, resulted in significant environmental savings, including:

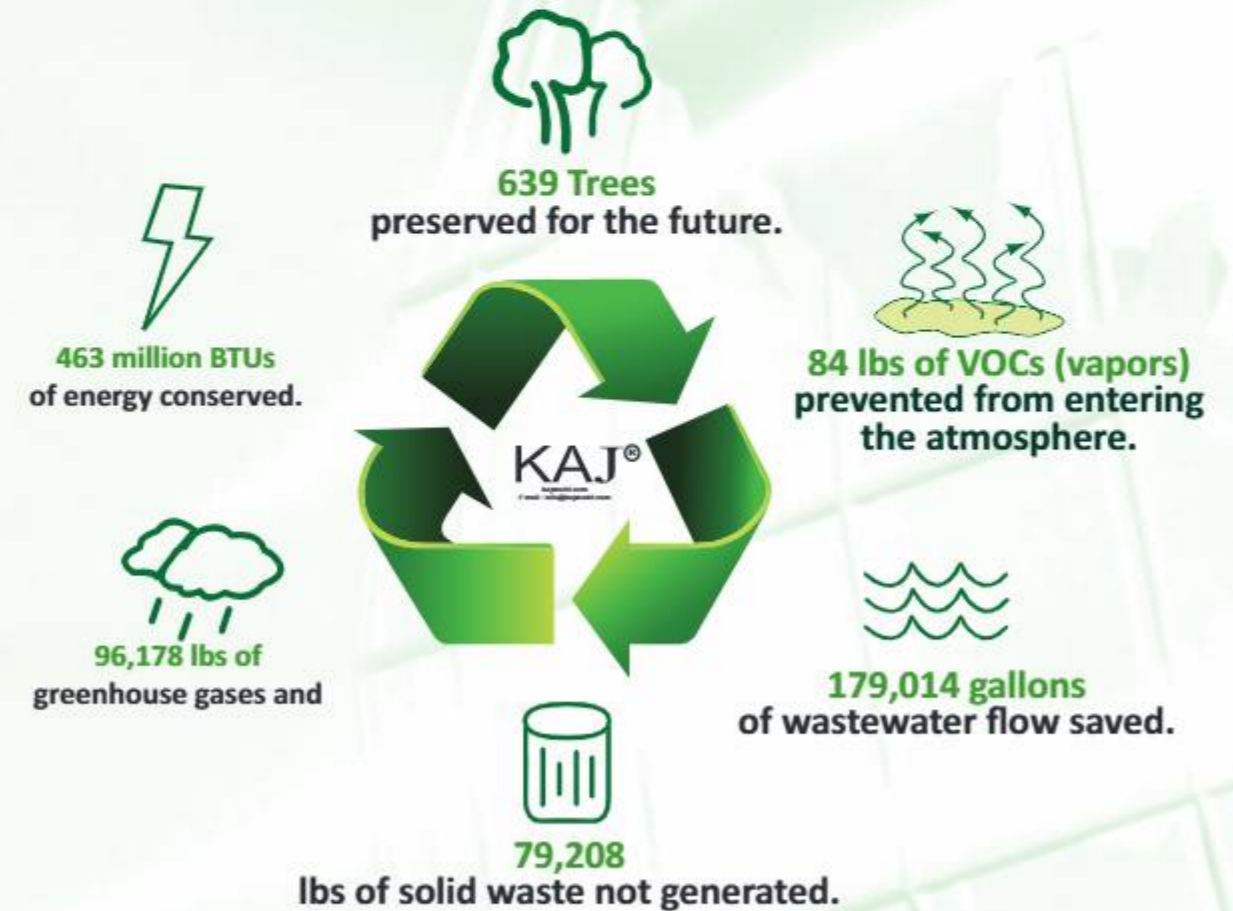

OUR PLANTS



Regd. Office: 74A, Charu Avenue,
 Kolkata, West Bengal, 700 033



Unit - I: Plot 27A (P) WBIIDC Growth Center, Uluberia
Dist. : Howrah - 711315, **State :** West Bengal, India



Unit - II: Monoharbahal, **P.O.:** Ethora, Asansol (North)
Dist. : Burdwan, **State :** West Bengal, India



Unit III : 3-7 Main Road Vallore, **Vill.:** Reddypally Colony
Mandal : Chegunta, **Dist :** Medak, **State :** Telengana, India

ABOUT KAJ

Manufacturer & Exporter of Ductile Iron & Cast Iron Castings
Municipal, Sanitary and Industrial Casting for Public Works Construction & Contracts MEP Projects
Heavy Casting like Manhole Covers, Frames, Grates.
Multiple certifications including ISO 9001 2008, ISO 9001 2015, ISO 14001 2015, ISO 45001 2018.

Installed Capacity 12000MT/Years
Equipped with all Physical, Mechanical, and Chemical Testing Facilities
Quality Control from Raw Material Incoming to Shipment of Finished Goods
3 Nos. 1000Kg Induction Furnace Crucible with 750 kW power pack,
1 Nos. 1000Kg Crucible with 1000 kW power pack
500 Kg batch capacity shot blasting.

Our Mission

Our goal is to be an influential and premier global business known for its advanced innovation and dedication to exceptional quality standards.

Our Vision

In a constantly changing world, we plan to achieve our long-term goals by finding and entering new markets, expanding into different industries, completely satisfying our customers, and constantly improving everything we do.



The Evolution of the Manhole Cover: From Cast Iron to Ductile Iron

The history of the modern manhole cover is a story of material science advancing to meet the increasing demands of urban infrastructure and heavier traffic loads. For centuries, manhole access points were covered by simple stone slabs (dating back to ancient Roman sewer grates), but the Industrial Revolution solidified gray cast iron as the standard material in the 19th century. Gray cast iron was strong and durable enough for early horse-drawn carriages and automobiles.

However, gray cast iron had a critical flaw: it was brittle. The graphite within its microstructure forms as sharp flakes, creating stress points that cause the cover to crack or shatter under high-impact conditions, heavy traffic, or sudden temperature changes.

The Invention of Ductile Iron

The revolution came in the mid-20th century. Ductile iron (also known as spheroidal graphite iron or nodular cast iron) was first discovered in 1943, with a U.S. patent granted in 1949. The innovation involved treating molten iron with a small amount of an element, typically magnesium, which causes the carbon (graphite) to solidify into tiny, rounded spherical nodules rather than flat flakes.

This unique microstructure fundamentally changed the metal's properties, giving it a high degree of ductility, or the ability to bend, twist, or deform without fracturing—qualities similar to steel, but at a much lower cost than steel production.

Adoption in Infrastructure

Ductile iron was introduced commercially in the 1950s, initially revolutionizing pressure piping systems. Its superior strength, impact resistance, and longevity soon made it the preferred material for manhole covers, replacing the older, more fragile gray cast iron.

Ductile iron manhole covers offered several key advantages:

Enhanced Safety: They could withstand heavier and faster traffic (like modern trucks and buses) without cracking or shattering, leading to fewer catastrophic failures.

Lighter Weight: Due to the material's superior strength-to-weight ratio, ductile iron covers could be made significantly lighter than gray iron covers while maintaining the same load-bearing capacity, making them safer and easier for municipal workers to handle.

Durability: They offered better resistance to corrosion and wear, significantly extending the lifespan of the covers and reducing long-term maintenance costs for cities.

Today, ductile iron is the global standard for heavy-duty manhole covers, representing a crucial step forward in making essential urban utility access reliable and safe for the public.

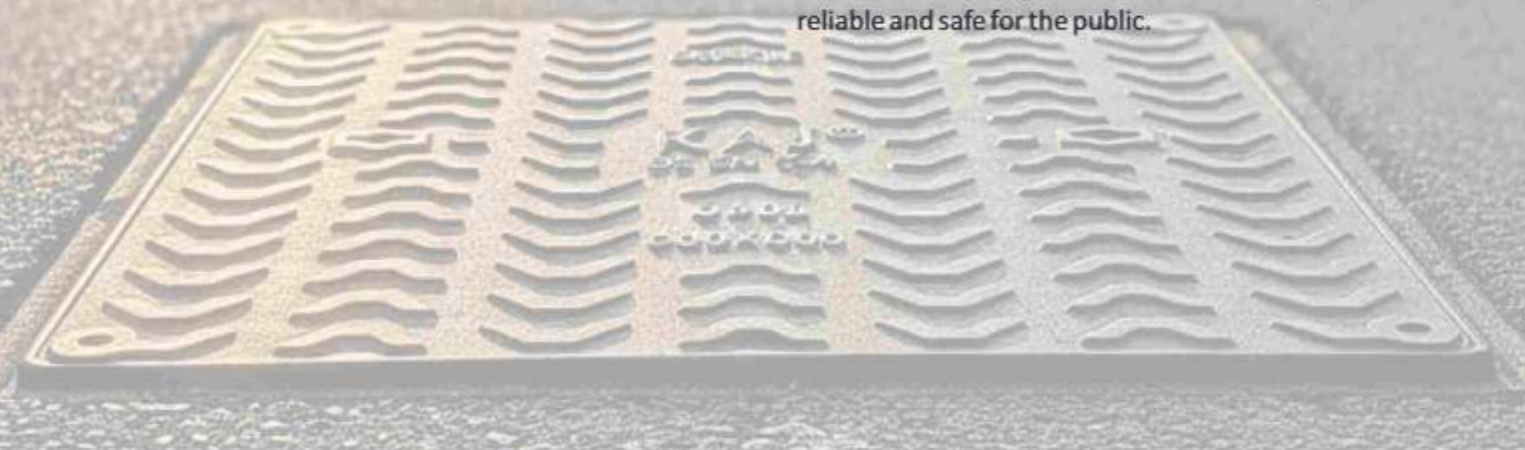

CHEMICAL PROPERTIES

Ductile iron, also known as spheroidal graphite iron or nodular iron, is a group of cast irons that exhibit high strength, flexibility, durability, and elasticity. It was developed in the mid-20th century. Unlike traditional gray cast iron, where graphite is in the form of flakes, the graphite in ductile iron is influenced by an additive (most commonly magnesium) to form spheroidal nodules. This unique microstructure inhibits crack propagation, giving the material its namesake ductility and significantly improved impact and fatigue resistance, making its mechanical properties similar to steel.

Chemical Properties:

Composition: It typically consists of 96% to 98% iron, 3.2% to 3.6% carbon, and 2.2% to 2.8% silicon.

Key Additives: Magnesium is the most critical additive, acting as a nodulizer to form the spherical graphite structure. Other elements like manganese, phosphorus, sulfur, copper, or rare earth elements may be present in small percentages to control microstructure and properties.

Structure: The matrix often consists of ferrite (pure, ductile iron) and/or pearlite (a mechanical mixture of ferrite and iron carbide, Fe₃C).

Best Way to Build Ductile Iron Manhole Covers: Ductile iron manhole covers are manufactured using a casting process, with the sand molding or V-

method casting being common practices. The general steps involve:

Melting and Treatment: High-quality iron is melted in a furnace. Once the required temperature is reached, magnesium is introduced to the molten iron to achieve the necessary ductile properties, ensuring the formation of spheroidal graphite nodules.
Molding: The treated molten iron is poured into prepared molds, typically made of sand (such as greensand) or using a vacuum-sealing process like V-method casting. The mold is formed based on the precise specifications of the manhole cover.

Cooling and Solidification: The molten metal is allowed to cool and solidify in the mold.

Finishing: Once cooled, the casting is removed from the mold, excess metal (sprue) is removed, and the surface is often shot-blasted to ensure a non-slip, rust-free, and flat finish.

Heat Treatment (Optional but Common): To further enhance mechanical properties like toughness and relieve internal stresses, the covers may undergo heat treatment, such as annealing.

The best method is generally a highly controlled foundry casting process that ensures the correct chemical composition, especially the magnesium treatment, and uses precise molding and cooling techniques to achieve the desired spheroidal graphite structure, resulting in a product that meets required load-bearing and safety standards.



Differences between Cast Iron, Ductile Iron, and Nano Composite manhole covers:

| Feature | Cast Iron (Grey) | Ductile Iron (DI) | Nano Composite |
 |--|--|--|

| Material | Iron with carbon in flake form. | Iron with carbon in spherical nodules (due to magnesium treatment). | Non-metallic polymer composite material, sometimes reinforced with fiberglass and nanomaterials. |

| Strength & Toughness | High compressive strength, but is brittle and prone to cracking under impact or stress. | Superior strength, toughness, and flexibility. Can bend slightly before breaking, making it better for heavy traffic. | High strength and durability. Excellent impact resistance; does not shatter like brittle materials. |

| Weight | Heavy. Heavier than a comparable Ductile Iron cover for the same load. | Lighter than traditional cast iron for the same load capacity, making it easier to handle. | Significantly Lighter (up to 70% less than metal covers), greatly improving installation and maintenance safety. |

| Corrosion/Rust | Prone to rust over time, especially in harsh or moist environments. | More corrosion-resistant than grey cast iron. | Completely rust-proof and corrosion-resistant (as it contains no metal). |

| Theft Risk | High scrap value, making it a frequent target for theft. | High scrap value, making it a frequent target for theft. | Zero scrap value, eliminating the risk of theft. |

| Main Use | Medium to heavy traffic areas where brittleness is less of a concern. | Heavy and Extra Heavy Duty traffic areas (highways, airports) due to high load capacity and toughness. | Light to Heavy Duty areas. Preferred where theft is a major concern or a lightweight, non-corrosive solution is needed. | In essence:

Cast Iron is the traditional, heavy, and brittle option.

Ductile Iron is an enhanced version—stronger, tougher, and lighter than Cast Iron for the same load.

Nano Composite is the modern alternative—lightweight, anti-theft (no scrap value), and completely rust-proof.



USAGE

Ductile iron manhole covers are primarily used in urban and industrial infrastructure to provide safe and secure access to underground utilities. Their main usages include:

Covering access points for sewer systems, water mains, stormwater drainage, and telecom networks.

Serving as a durable barrier in heavy and high-traffic areas such as highways, main roads, industrial zones, airports, and loading docks due to their superior strength and ability to withstand heavy loads.

They are preferred for their durability, high strength-to-weight ratio, impact resistance, and better resistance to cracking and corrosion compared to traditional grey cast iron.



DUCTILE IRON

Product Range



Includes an infiltration feature which drastically reduces surface water ingress.



Includes integrated anti-fall protection.



(For gully gratings only)
 Includes a specially designed grating for use in pedestrian areas.



Includes an ergonomically positive opening feature. Gold indicates a fully ergonomic opening system. Silver indicates a semi-ergonomic inspection system.



Includes a security feature to deter unauthorised access ranging from high security (gold) to lesser locking levels.



(For gully gratings only)
 Indicates the level of absorption efficiency of a grating ranging from high (gold) to lesser levels.



For access covers only
 Includes a feature which reduces egress of unwanted odour ranging from high resistance (gold) to lesser levels.

Product Selector

Class A15

Access covers and gratings capable of with standing a 1.5 tonnes test load. For use in areas where only pedestrians have access.

Class B125

Access covers and gratings capable of with standing a 1.5 tonnes test load. For use in car parks and pedestrian areas where occasional vehicular access is likely.

Class C250

Access covers and gratings capable of with standing a 25 tonnes test load. For use in areas where not extending more than 500mm from the kerb face into the carriageway.

Class D400

Access covers and gratings capable of with standing a 40 tonnes test load. For use in areas cars and lorries have access, including carriageways, hard shoulders and pedestrian areas. All units to be either non- rock or silent in operation.

Class E600

Access covers and gratings capable of with standing a 60 tonnes test load. For use in areas where heavy wheel loads are imposed such as loading areas, docks or aircraft pavements.

Class F900

Access covers and gratings capable of with standing a 90 tonnes test load. For use in areas where very heavy wheel loads are imposed such as aircraft pavements.

Load Classes



Example:
 Pedestrians and cycle ways, garage doors, domestic drives, dawned areas.



Example:
 Light Vehicle driveways, private car parks, pedestrian precincts



Example:
 Service stations (cars), park side areas, paved areas, kerb sides



Example:
 Carriageway locations, service station fore courts, public areas



Example:
 Industrial areas, forklifts, dock sides



Example:
 Airport runways, service yards and lorry parks, military bases



Includes the Load Transfer System (LTS) feature for optimum installation and durability.

The *Kaj* range of highway products is manufactured in accordance with the relevant European or British Standard performance specification BS 5834 and BS 750 for surface boxes.

The symbols detailed below are those incorporated in the selection box in the 'At a glance' section, indicating recommended applications and allowing appropriate product selection.

AT A Glance



The *Kaj* selection box in the 'At a glance' section of the product pages is a quick reference guide to product selection and enables important performance and product specification criteria to be assessed quickly and conveniently.



The gold and silver indicators identify the added benefit each product provides. level of



(For access covers only) Includes a feature(s) that offers improved skid and slip resistance.

STANDARD CLASSIFICATION

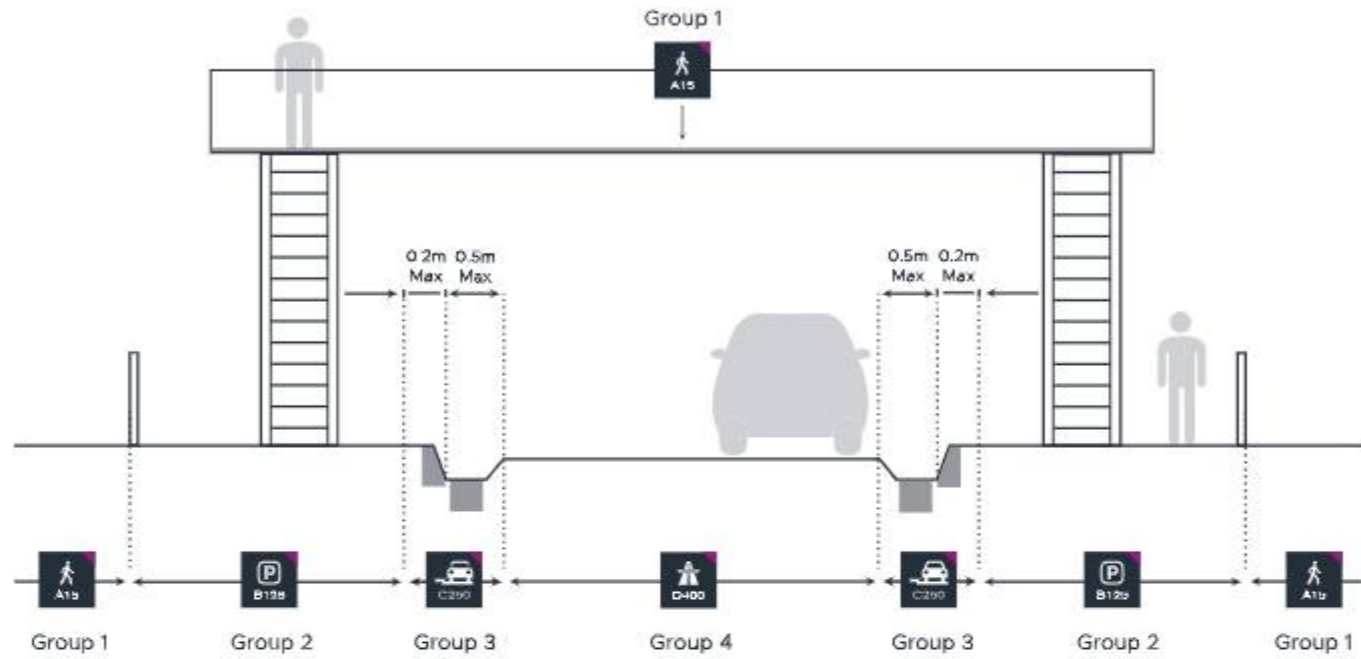

GROUP 1 - CLASS A15

Manhole covers and gratings capable of withstanding a 1.5 tonne test load. For use in areas which can only be used by pedestrians and cyclists.

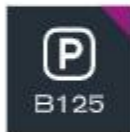

GROUP 2 - CLASS B125

Manhole covers and gratings capable of withstanding a 12.5 tonne test load. For use in foot-ways, pedestrian areas and comparable areas such as car parks.



GROUP 3 - CLASS C250

Manhole covers and gratings capable of withstanding a 25 tonne test load. For installation no more than 500mm from the kerb face into the carriageway.

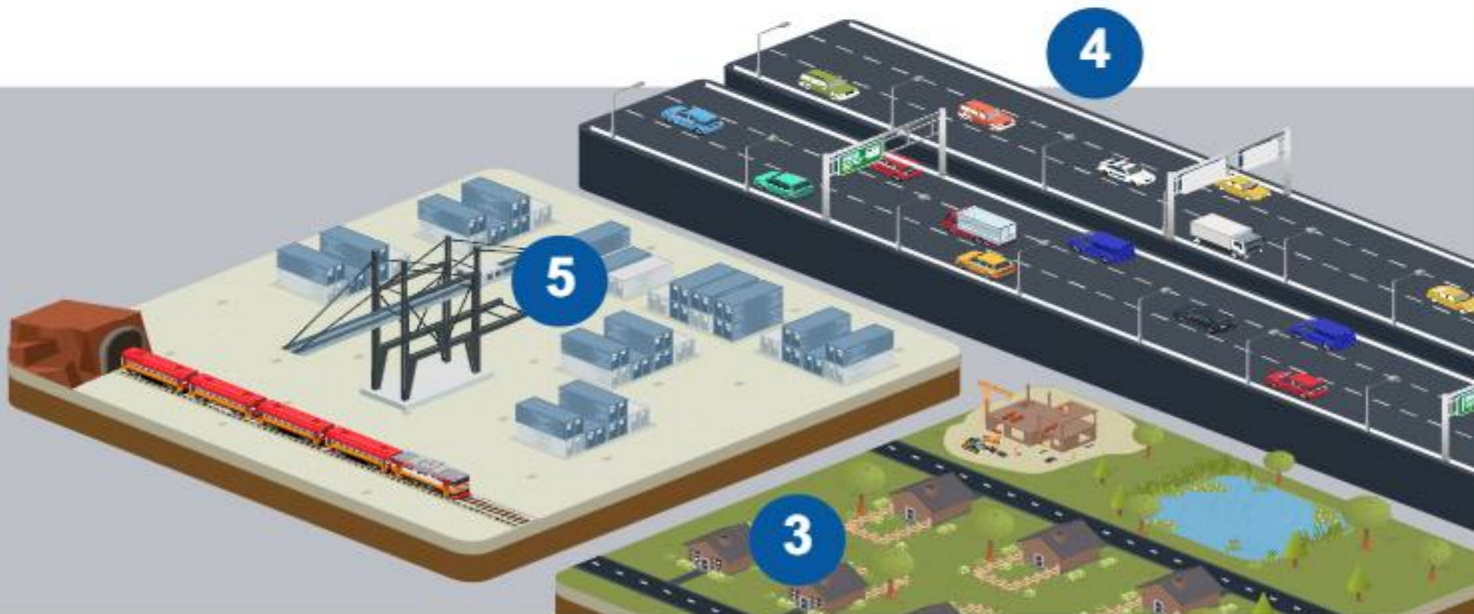

GROUP 4 - CLASS D400

Manhole covers and gratings capable of withstanding a 40 tonne test load. For use in areas where pneumatic-tyred cars and lorries have access, including carriageways, hard shoulders and pedestrian areas. All units to be either non rock or silent in operation.



GROUP 5 - CLASS E600

Manhole covers and gratings capable of withstanding a 60 tonne test load. For use in areas where heavy wheel or high point loads from pneumatic and non-pneumatic-tyred vehicles are imposed, such as loading areas or docks.



Infrastructure & Facilities Pattern Shop



PATTERN SHOP

- Completely equipped to manufacture Aluminum and Wooden Patterns in-house with high degree of accuracy.
- Modern pattern inspection and repairing section to facilitate immediate changes to pattern design and pattern repairing with minimum downtime.
- Double Column Vertical Sectioning Machine for sectioning castings & inspection of sizes up to 1000 x 10500mm.
- International standard, state of the art pattern storage system having minimum of 500 sets of pattern storage capacity.
- Any pattern can be traced and be made available within 5 minutes.
- Modern Fork Lift (Flexi) for easy access to each pattern on the pattern storage system.
- Co-ordinate Measuring Machine (CMM) for accurate dimension checking.
- Vertical Machining Centre (VMC) for pattern making.
- Bank of conventional machines like lathes, drill machines, shaping machines and wood cutting machines.
- All measuring instruments are International Standard.



Machining & Pattern Making Process

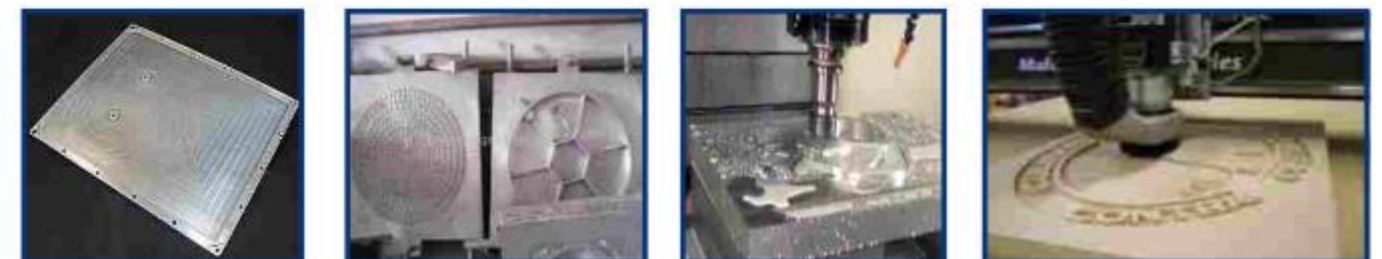
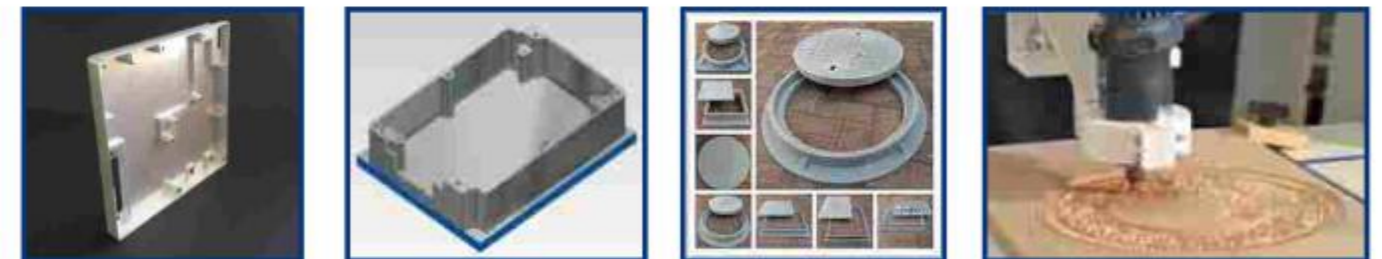
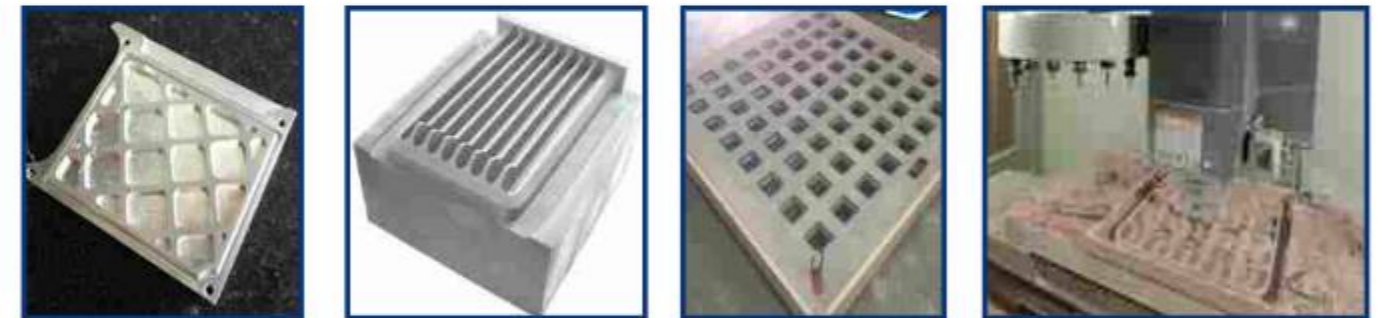

Infrastructure & Facilities Testing Facilities

- 3 Muffle furnaces with temperatures ranging from 50°C to 1400°C
- Digital hot air oven (to remove moisture) with max temperature of 250°C
- Digital ph meter with auto temperature compensation.
- Chain o Matric Chemical Balance.
- Digital Single Pan Balance.
- Mercury Barometer.
- Digital Dry & Wet Bulb Hydrometer.
- Distillation Apparatus.
- 2 Hot Plates arranged in fume chamber for wet analysis.
- Digital Balance.
- Analytical Balance.

SAND TESTING EQUIPMENT

- Sand Rammer with Base Block. Compatibility & strength
- Permeability Meter
- 2 Digital Universal Strength Testing Machine for checking Compression strength, Shear strength, Tensile strength & Transverse strength in Green Molding sand, Cold Box & No Bake sand.
- Digital Moisture Tester
- Rapid Moisture Tester
- Sieve shaker with Timer & set of sieves
- Compatibility Tester same as Ramer
- Mould Hardness Tester (Scale B & Scale C)
- Core Hardness Tester
- Sand Muller (Capacity – 5 kgs.)
- Calibration Kit for Digital Universal Strength Testing Machine
- Calibration Kit for Permeability meter.
- Calibration Kit for Rapid Moisture Tester
- Test bar storage up to 1 year from manufacturing date to enable traceability of castings to the particular date of casting and heat no.



Infrastructure & Facilities Testing Facilities

On Line Digital Laboratory



Alient Features

Actual cooling curve is stored.
 Job-wise parameters and target values are stored and used
 Existing equipments can be upgraded to ONLINE Color codes for different types of metals for convenience Features with CE cups.



Nodule Count

Secondary shrinkage

Solidification mode of treated metal : Hypo-Eutectic, Eutectic, Hyper-Eutectic or their combination is detected. Carbides detection Residual Magnesium detection Features with Carbon cup.



Can analyse composition of very high CE values Target levels for each job to alert the operator Job, Heat / Melt number, Iron type are stored for data analysis Job wise charge calculation can be seen Facility to feed composition of Steel, Pig iron, returns etc to calculate charge mix Recommended alloy addition from results of Spectrometer / Carbon Silicon Analyser is displayed.



Infrastructure & Facilities Testing Facilities



Testing Facilities

Physical Testing Equipment

- 1 optical Spectrometers (make Ametek Germany) having 25 channels.
- 1 Spectrometers (make Ametek Germany) having 19 channels.
- Microscope with Image Analyzer (make Dewinter Germany) for Direct Data of Metal, Flake Graphite size, Nodule size, Nodule Count, Nodularity, Pearlite & Ferrite percentage, etc. The Microscope can achieve a normal Magnification of 1000 and a Digital Magnification of up to 4000.
- Two Optical Brinell Hardness Testing Machines
- One Brinell Hardness Testing Machine with B.I.M.S software
- Electronic Universal Tensile Testing Machine (60 tons capacity)
- Surface Grinding machine for spectro sample preparation (Make STG- 6)
- Cutter machine for Micro sample preparation (Make – Metacut)
- Double disc micro polishing machine (Make - Metapol)
- Impact testing machine for V-notch charpy impact test.
- Table grinding machine.



COMPLETE WET LABORATORY EQUIPMENTS

- Strohle in apparatus for carbon determination
- Instrument for Continuous temperature monitoring with Digital Display

Infrastructure & Facilities Drawing & Design

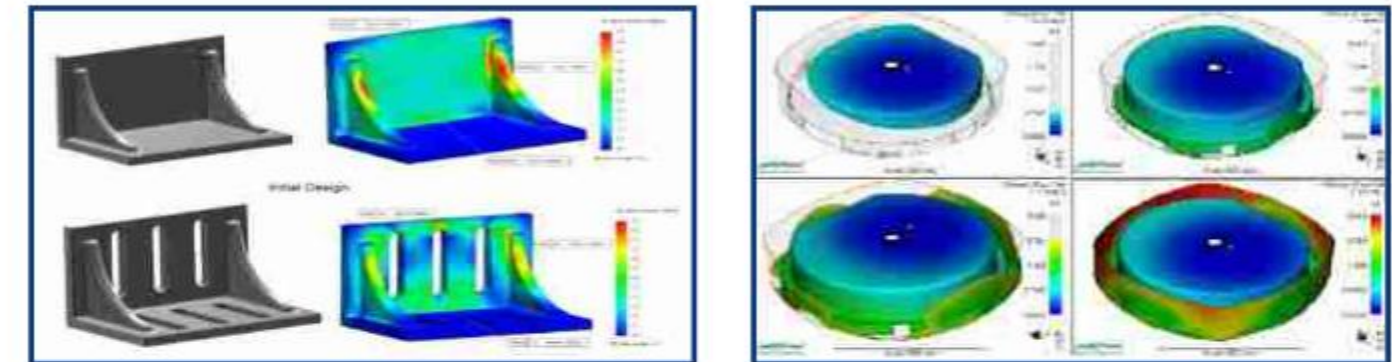

Kaj uses complete 3D software tools that let us to create, simulate, and produce your product 100% defect free. It enables our company to quickly transform new ideas into greater products. Our software simplifies design with its intelligent designs tools, comprehensive parts database and real-time integration of 2D schematics and 3D models. Our software bring their designs to life and shape their own success stories.

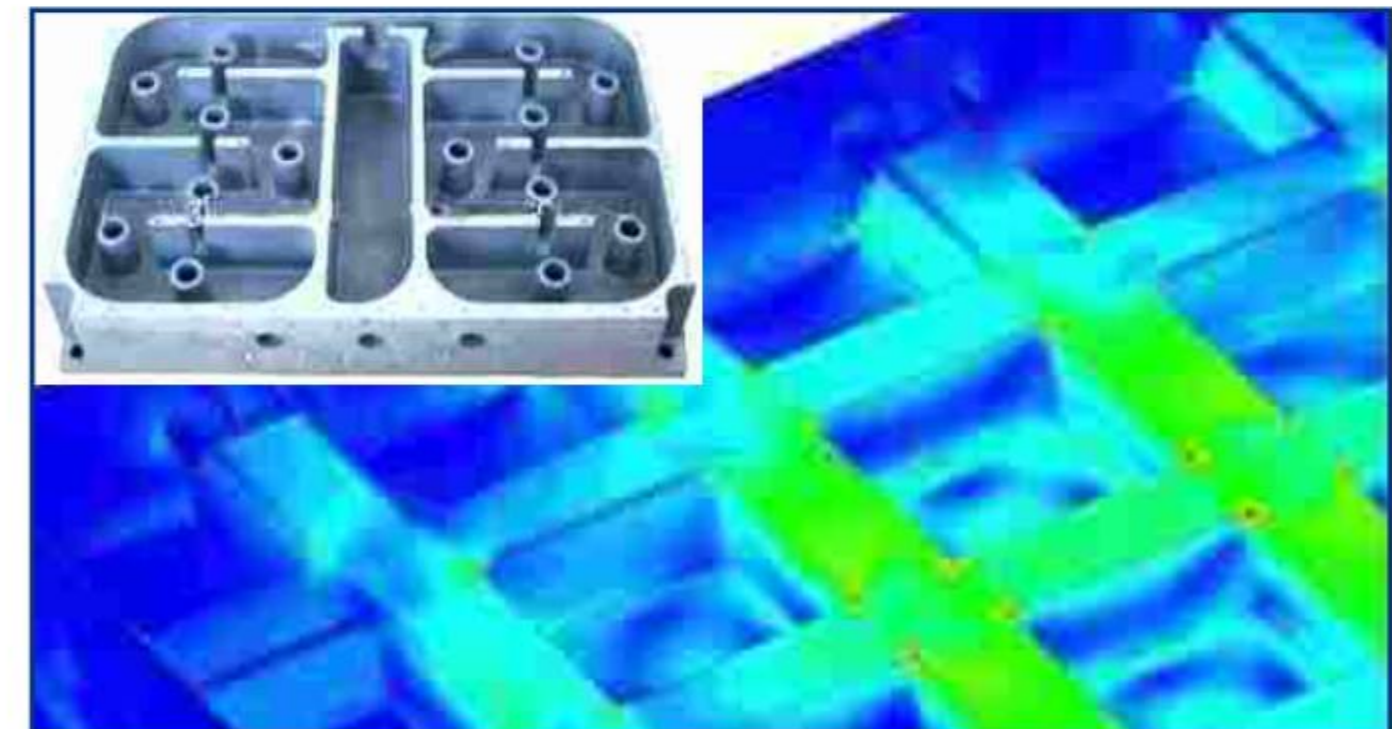

Infrastructure & Facilities Drawing & Design

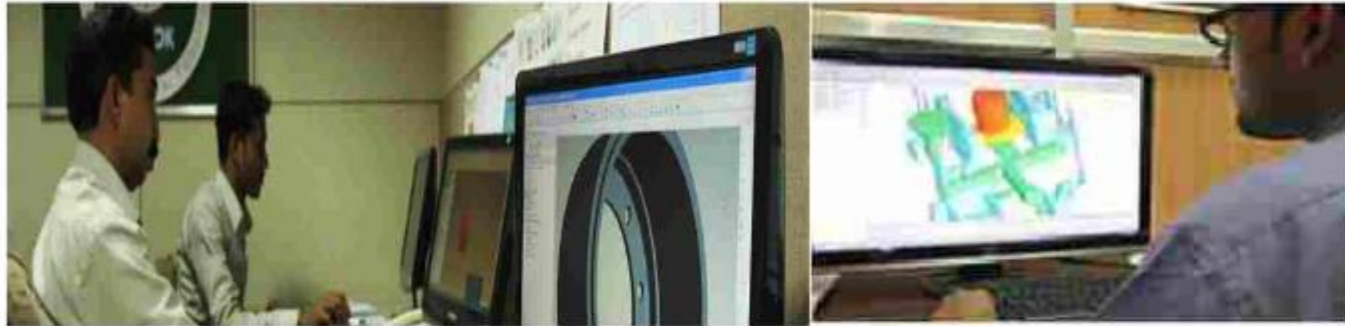

In House Design Facilities

- ✍ 3D modeling with high-end software like AUTO CAD 2017 Mechanical, Pro Engineer – Professional wild fire 3, SOLID WORK, Delcam
- ✍ Simulation for Mould filling, Model Building, Solidification, and Microstructure with the help of Novacast Computer Aided Engineering (CAE) Advanced 3.1.
- ✍ Pro Mechanica Software for Load Simulation/testing of Manhole Covers under Laboratory Conditions
- ✍ Software reduces Lead development time for new products and for any modifications in existing products



Infrastructure & Facilities

Testing Facilities Chemical Laboratory



we are fully equipped to meet all your specific needs and requirements within the specialised foundry and castings industry sector. Chemical analysis, mechanical testing, corrosion testing by salt spray or humidity tests and metallographic testing including SEM/EDAX.

Our laboratories provide an extensive range of other testing which, can help deliver the assurance and advice needed to validate your processes and products from receipt of raw materials such as ingots and recycled materials through to final casting product quality assurance.



Infrastructure & Facilities

Testing Facilities

Digital Microscope & Image Analysis Software

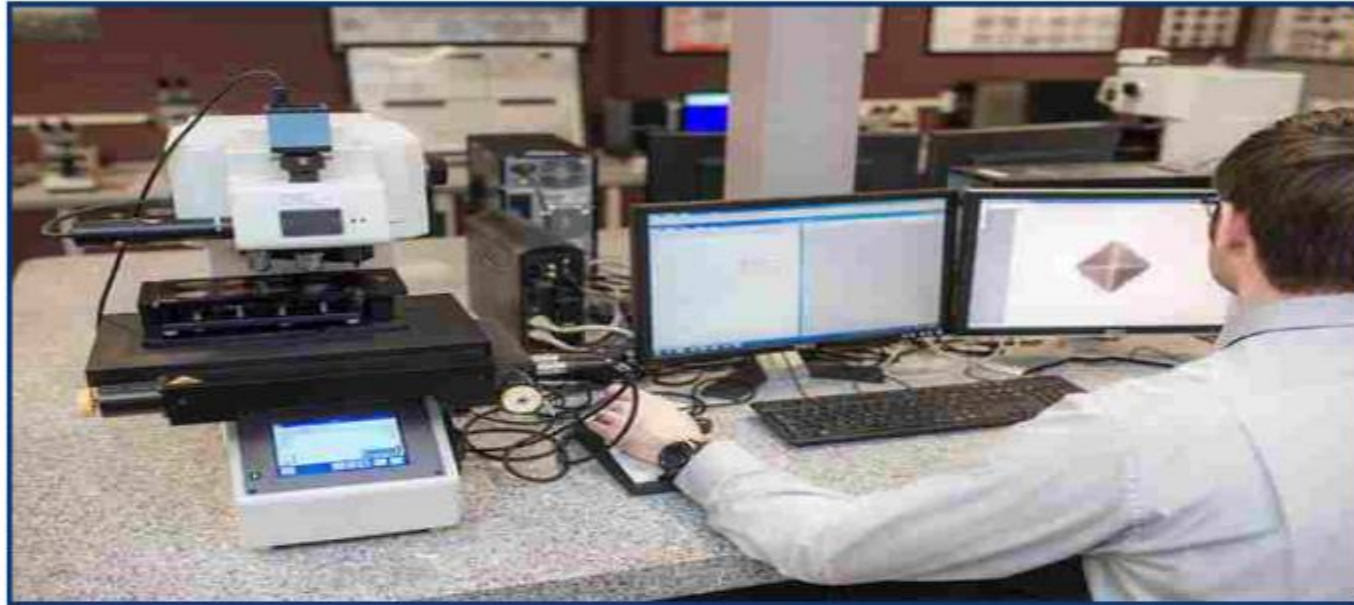

We have great expertise in crafting of Industrial / Metallurgical Microscopes which are reliable and durable. These microscopes provide excellent output which is free from error. We make sure that quality is never compromised while the creation of the products.

The compound microscope has two systems of lenses for greater magnification, 1) the ocular, or eyepiece lens that one looks into and 2) the objective lens, or the lens closest to the object. Before purchasing or using a microscope, it is important to know the functions of each part.

Two convex lenses can form a microscope. ... The ocular lens makes the light rays spread more, so that they appear to come from a large inverted image beyond the objective lens. Because light rays do not actually pass through this location, the image is called a virtual image.

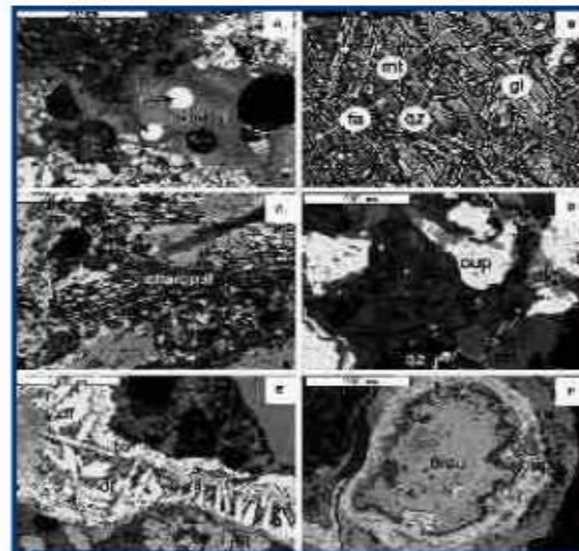
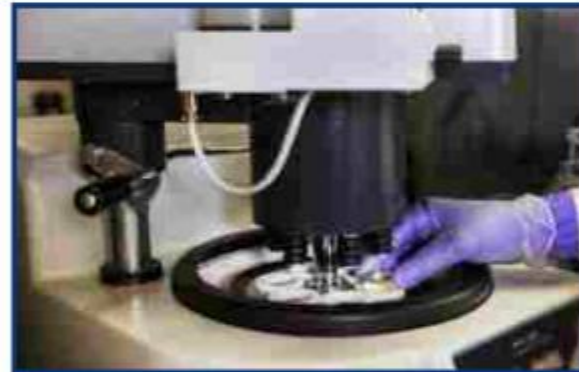

Infrastructure & Facilities

Testing Facilities

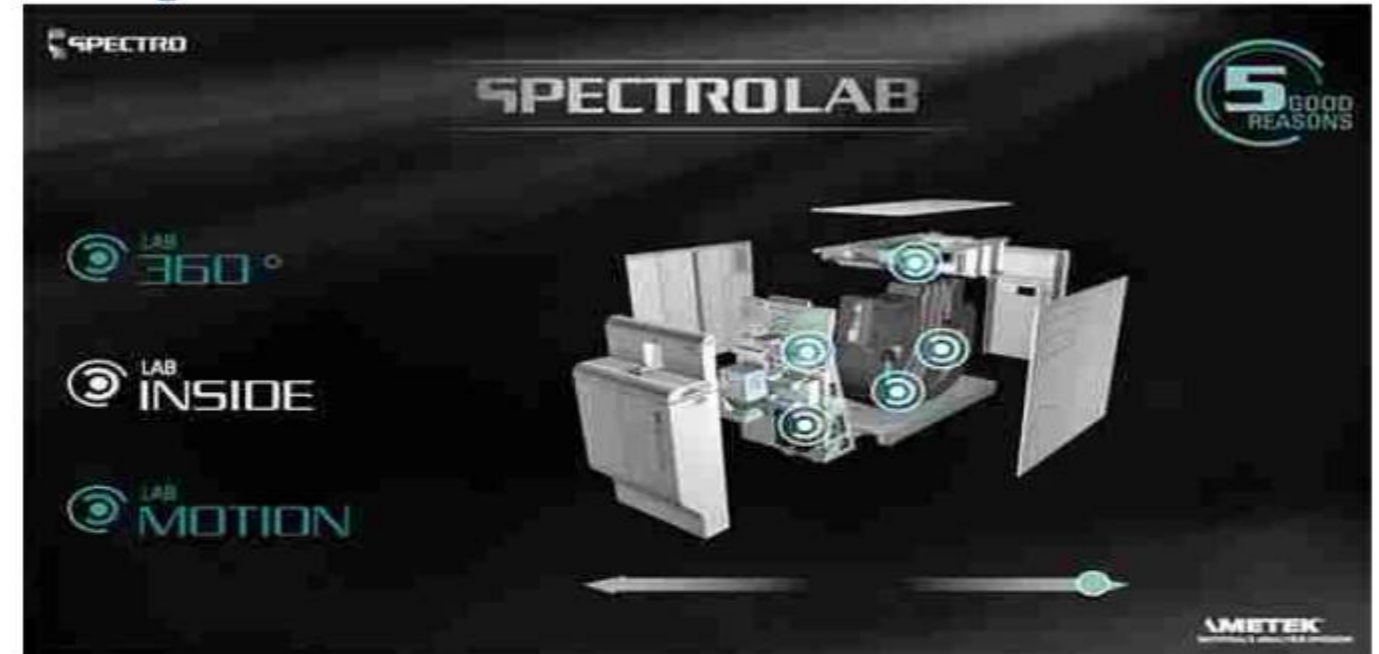

A spectrometer is a device for measuring wavelengths of light over a wide range of the electromagnetic spectrum. It is widely used for spectroscopic analysis of sample materials. The incident light from the light source can be transmitted, absorbed or reflected through the sample.

A spectrometer is any instrument used to probe a property of light as a function of its portion of the electromagnetic spectrum, typically its wavelength, frequency, or energy. The property being measured is usually intensity of light, but other variables like polarization can also be measured. A spectrophotometer is an instrument that measures the amount of photons (the intensity of light) absorbed after it passes through sample solution. With the spectrophotometer, the amount of a known chemical substance (concentrations) can also be determined by measuring the intensity of light detected.

Spectrometers are able to detect light intensity versus frequency. This is important because objects emit or reflect light based on their composition and energy levels. Hot objects emit light on specific wavelengths based on what, chemically, is hot.

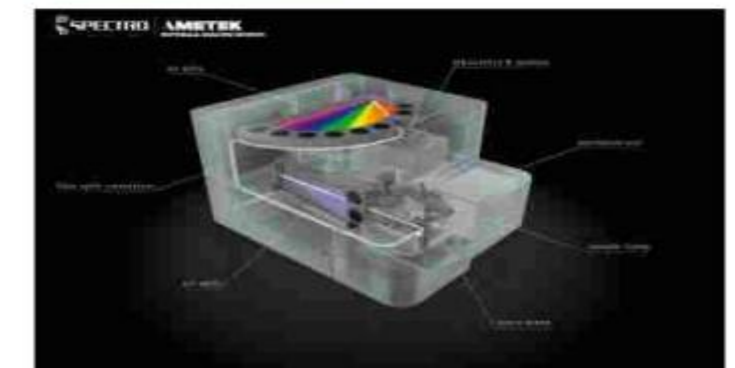
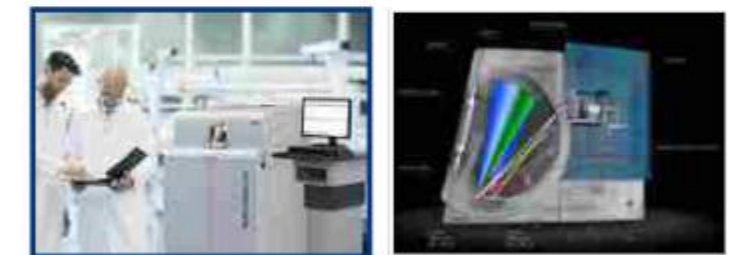

Installation Process

Lift and Rotate Cover

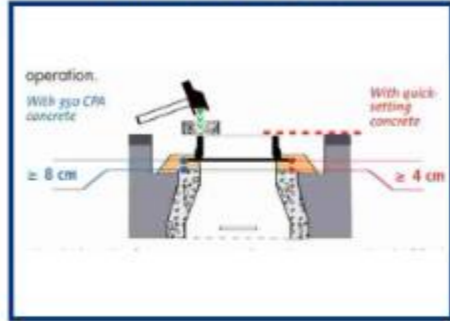

To open the cover, slightly lift, and rotate the cover. The patented design provides cover lift and rotation with minimal effort. Worker safety is improved by eliminating the need to hoist heavy covers when opening or closing the elevated unit.

Resists Water Infiltration



The surface of the cover extends slightly past the edge of the frame, and the neoprene gasket helps seal the unit against water infiltration. A watertight seal can be achieved with the four bolt design.

Important Safety Information



Securely bolt the frame to manhole cone on 29 3/4" bolt circle. Do not subject cover to any load when in open position. Do not install in areas of vehicular traffic.

REVOLUTION Size Options

Clear Opening Dia.	Series No.
24	1040 and 4138
28	1890
30	4142

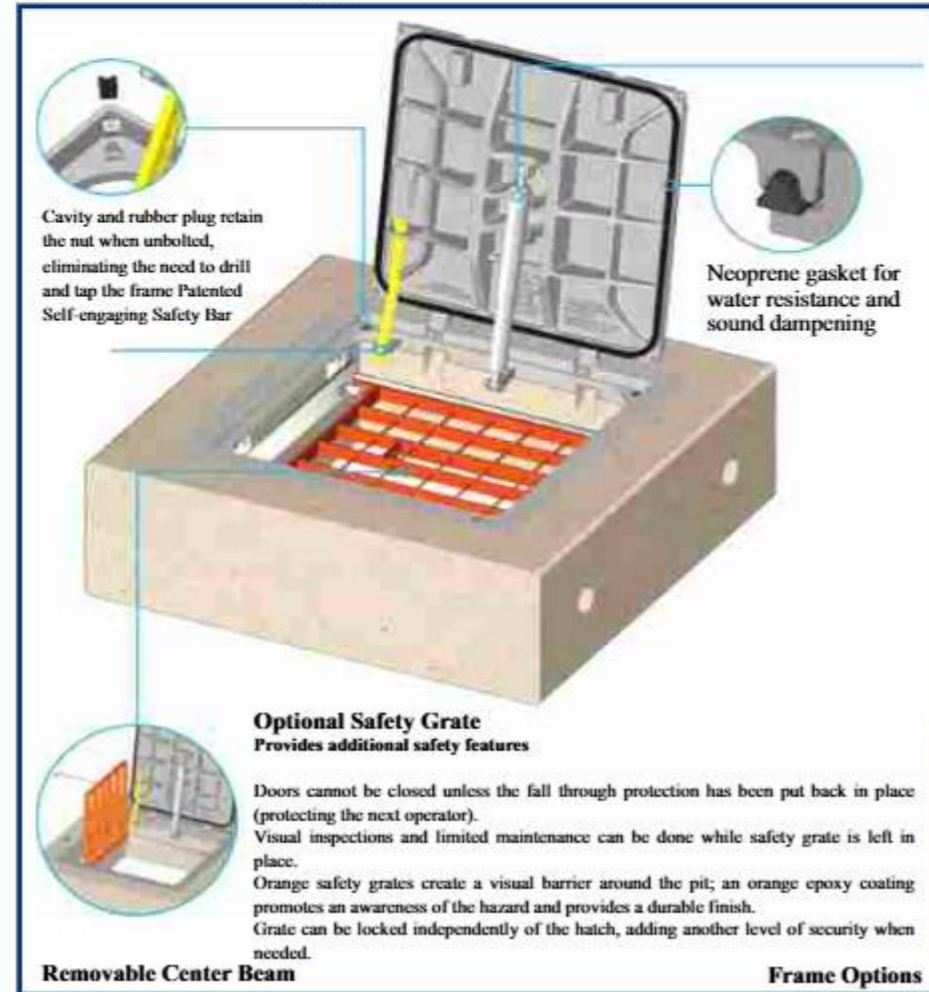

Lift Assist

Lift Assist is a corrosion-resistant stainless steel mechanical spring strut. The rugged design is clean and maintenance free. The strut takes up less space in the clear opening than a traditional spring assist. It is fully self-contained, protecting coils from exposure to the elements.

Made without internal gases or seals, the struts have an effective operating temperature range of -30° F to 400° F. The durability has been tested at over 150,000 cycles.



Security cam lock and wrench shown. Wrench is only removable when cover is in the locked position.



Infrastructure & Facilities Testing Facilities

Digital Microscope & Image Analysis Software

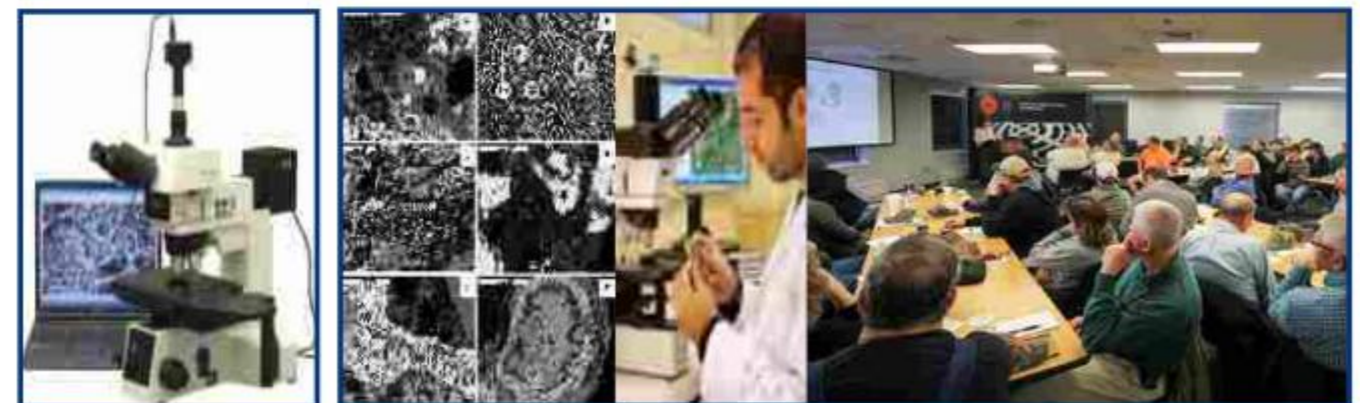

● SERVICE ● SUPPLY ● INSTALLATION

Manhole Cover Installation: Process, Safety, and Equipment

This guide provides a comprehensive overview of the proper procedures, essential equipment, and mandatory safety guidelines required for the professional installation of manhole covers and frames (sometimes referred to as access covers).

I. Essential Equipment and Materials

The following equipment and materials are required to ensure a correct, safe, and durable installation:

A. Safety & Personal Protective Equipment (PPE)

- High-visibility vests and clothing.
- Safety helmets (hard hats).
- Steel-toed safety boots.
- Work gloves (suitable for masonry and handling heavy castings).
- Safety glasses or goggles.
- Traffic control barriers, cones, and appropriate signage.
- Gas detection monitor (if entering the manhole/sewer access).
- Retrieval equipment (tripod and winch) for deep access chambers.

B. Tools and Machinery

- Mechanical lifting equipment (e.g., small crane, Hiab, or specialized lifting gear) or manual lifting tools (if the cover and frame weight allows for safe two-person lift).
- Chisels, hammers, and demolition bars for concrete removal.
- Trowels and floats for mortar/concrete application.
- Spirit level or digital level for alignment.
- Tape measure and marking chalk/spray.
- Concrete saw (if adjusting the surrounding pavement).
- Compaction plate or tamper (for backfill/sub-base).



1. Site Preparation and Safety Zone

Establish Safety Zone: Install traffic control barriers, cones, and signage according to local regulations to isolate the work area.

Remove Old Cover: Carefully lift and remove the existing manhole cover using appropriate lifting keys and safety procedures.

Excavate: Remove the existing manhole frame, bedding, and surrounding paving/concrete to create a stable, adequately sized aperture for the new frame. Ensure the excavation is wide enough to allow for a proper bedding depth.

Clean and Inspect: Thoroughly clean the top surface of the manhole chamber structure (corbel or surrounding concrete) to remove all loose debris, dust, and old mortar. Inspect the chamber structure for damage; any cracks must be repaired before proceeding.

2. Bedding and Frame Setting

Prepare Bedding Material: Mix the chosen bedding mortar or compound according to the manufacturer's instructions. The mix consistency should be stiff enough to support the frame without slumping.

Apply Bedding: Apply the bedding material evenly across the cleaned bearing surface of the manhole chamber structure. The depth should be sufficient to set the frame to the final required surface level.

Set the Frame: Carefully lower the new manhole frame into the bedding material, ensuring the frame is oriented correctly (if directional).

Leveling and Adjustment: Immediately use the spirit level to ensure the frame is perfectly level in all directions and is flush with the surrounding road or pavement surface. Adjust the height by gently tapping the frame down into the bedding.



Production Flow Chart

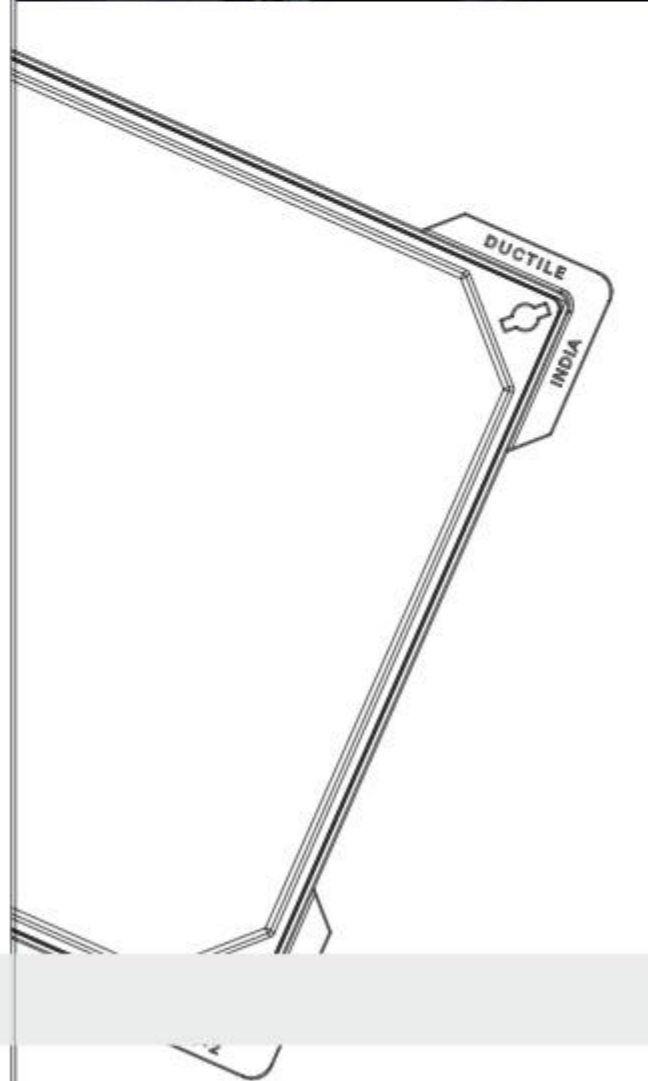
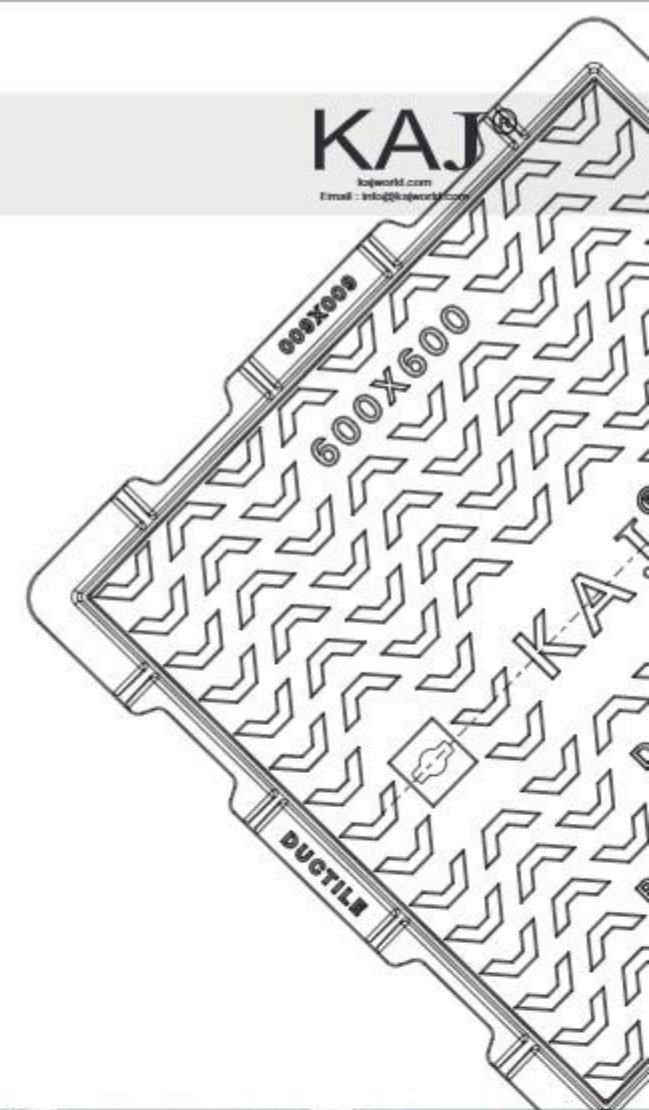
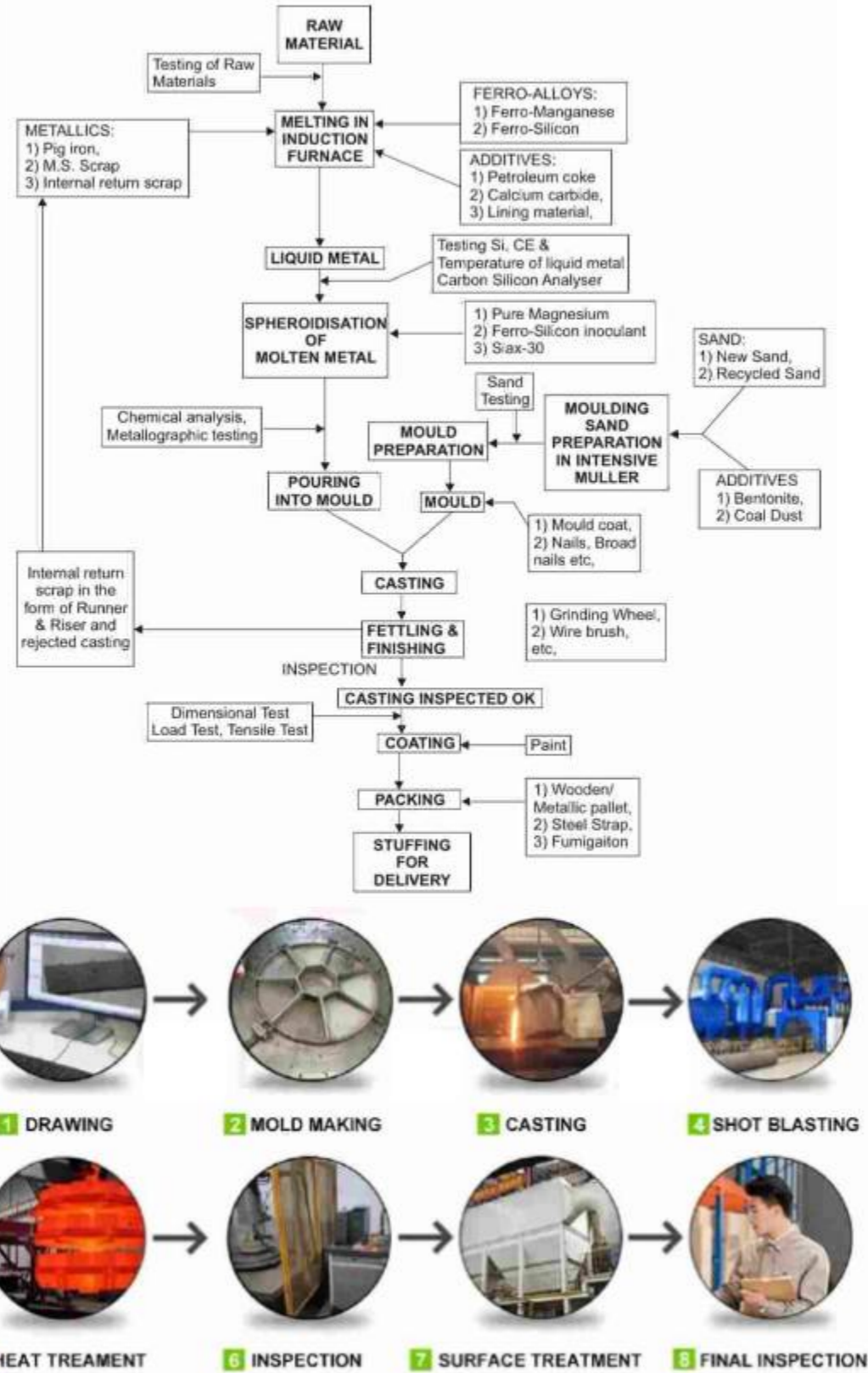

FACTORY VISIT



FACTORY VISIT



FACTORY VISIT



FACTORY VISIT





The BSI Kitemark is a UK-based certification mark that verifies a product's conformity to specific standards. It's particularly important for products where safety is crucial, such as manhole covers. The BS EN 124:2015 standard for manhole covers and gully grates requires compliance with UKCA marking, and BSI's Kitemark serves as independent proof of this compliance. Technical Marking and Accountability

A Kitemarked product provides essential traceability. In addition to the standard EN 124 marking requirements, Kitemarked covers must clearly display:

- * The BSI Kitemark logo
- * The BSI Licence Number (KM\...)
- * The Product Standard Number (e.g., BS EN 124-2:2015).
- * The appropriate Load Class (e.g., D400).

The presence of the Kitemark assures specifiers that the named manufacturer on the cover is the legally accountable entity responsible for the product's design, manufacturing control, and proven compliance, thereby reducing project risk and liability.



DOES IT MATTER?

The Kitemark ensures that products are manufactured to high standards, are durable, and meet specific requirements. To bear the Kitemark, products must meet certain marking requirements, including:

- EN 124-2 standard number
- Class designation (e.g., D 400)
- Manufacturer's name and identification mark
- Factory of manufacture
- Date or week and year of manufacture

KAJ has achieved a notable milestone by becoming the first company worldwide to receive the Kitemark for its entire range of ductile iron access covers and gratings, demonstrating its commitment to quality and safety.

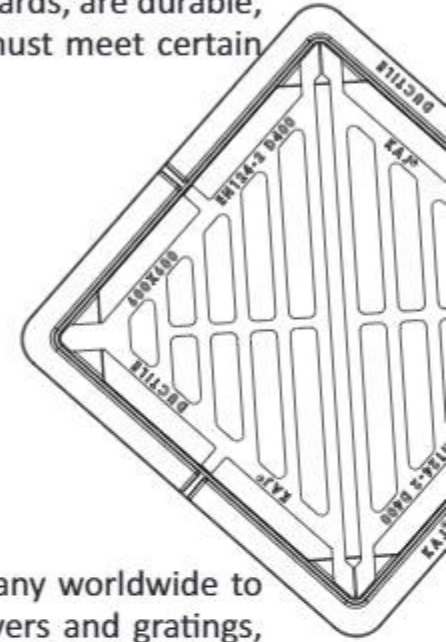

What to Look for: BSI Kitemark Marking Rules

In addition to the standard BS EN 124 marking requirements, BSI has specific rules for how the Kitemark must be displayed on a product. These rules ensure that customers and inspectors can easily confirm the product's compliance:

1. Association and Location: The BSI Kitemark logo must be placed close to its licence number and the **product standard (e.g., BS EN 124-2:2015). Ideally, the text should be directly underneath the logo, but the key is that they are grouped together to show their relationship and clearly separate them from other markings on the product.
2. Colour: The Kitemark logo and licence number text must be displayed in the same colour.
3. Legibility: Both the Kitemark logo and licence text must be large enough to be easily read, with a minimum size of 5pt required for the text.

The presence of the BSI Kitemark, displayed correctly, serves as a guarantee that the product conforms to the relevant standards.



KAJ NON-KITEMARK SERIES



300X300 X50 D 400 SOLID TOP MANHOLE COVER WITH GRP SEALING PROVISION

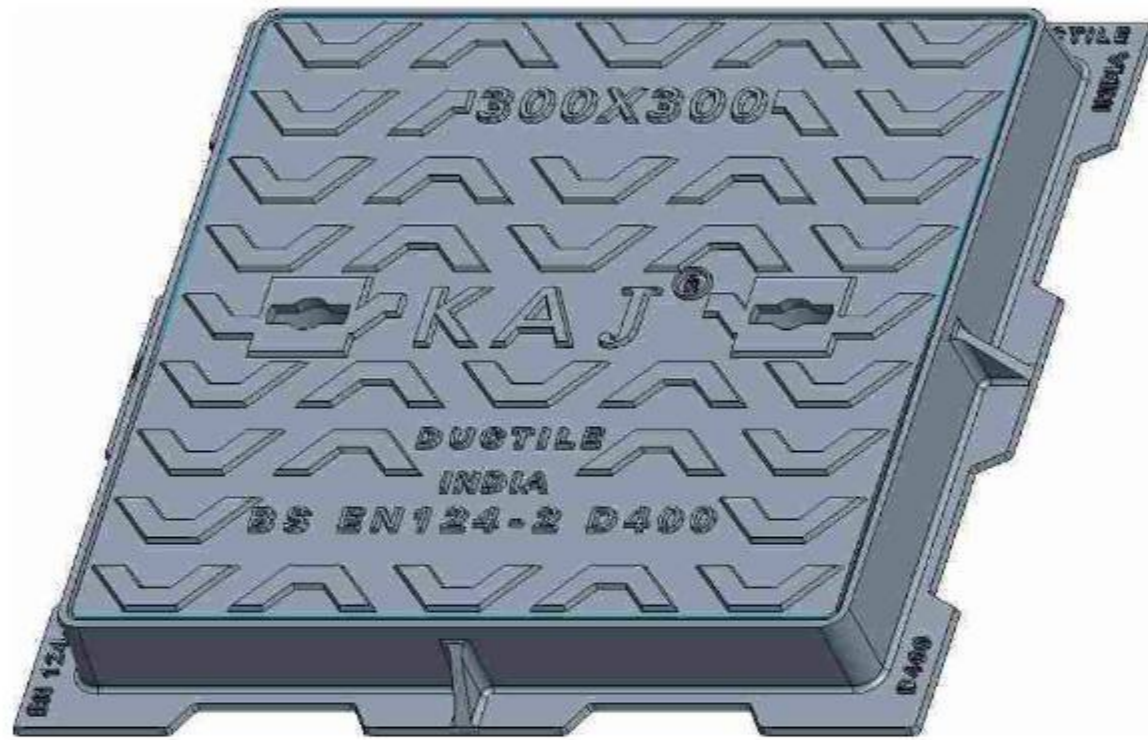

D400 Manhole Covers manufactured to BS-EN 124-2 Compliant skid resistant for high risk location



Anti-flex covers prevent the causes of cover seating wear, eliminating excessive noise and catastrophic failure.



Specially designed cover support geometry reduces movement relative to the frame, minimising seating wear.



Enlarged frame corners help to dissipate, load minimising bearing pressure.



Indexed corners ensure correct orientation first time, every time.



Inspection window allows safe and easy view into chamber.

300X300 X50 D 400 SOLID TOP COVER AND FRAME

S#	CLEAR OPENING AxA (MM)	OVER BASE BxB (MM)	TOTAL HEIGHT H (MM)	LOAD CLASS	FEATURES	KITE MARK
1	300 X 300	450 x 450	50	D- 400	Double Seal/ GRP PROVISION	NO

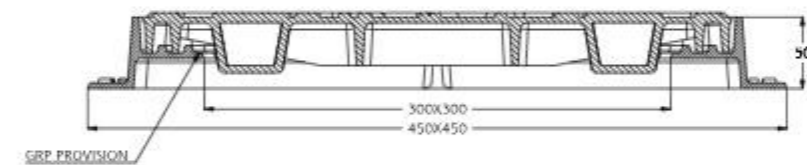

SECTION A-A

FEATURES:

1. Manufactured as per BS EN 124 -2 Design Standard
2. Can also be designed with a concealed locking mechanism for safer access
3. Load achieve before concrete filling
4. Designed to non-rock
5. Can be provisioned for Gasket and GRP seating
6. Custom Marking/ Logos available on request

REV. NO	DATE	MODIFICATION	NAME	DATE	SIGN.	DRAWING DESCRIPTION:- 300X300 SOLID TOP D400 FRAME AND COVER (WITH GRP)	SHEET NO:- 1 OF 1
			DRWN. BY:- T.R.B	20.02.23			
			CHKD. BY:- R.Mukherjee	20.02.23			
			APPRD. BY:- T.R.B	20.02.23			
			MATERIAL:- DUCTILE IRON EN1563-500/7				
			TOLERANCE:- ISO 8062 (CT-11)				
			BRAND:- KAJ				
				LOAD:- D400			
				SCALE:- NTS			
			ALL DIMENSIONS ARE IN MM.				

300X300X50 B 125 SOLID TOP MANHOLE COVER WITH GRP SEALING PROVISION

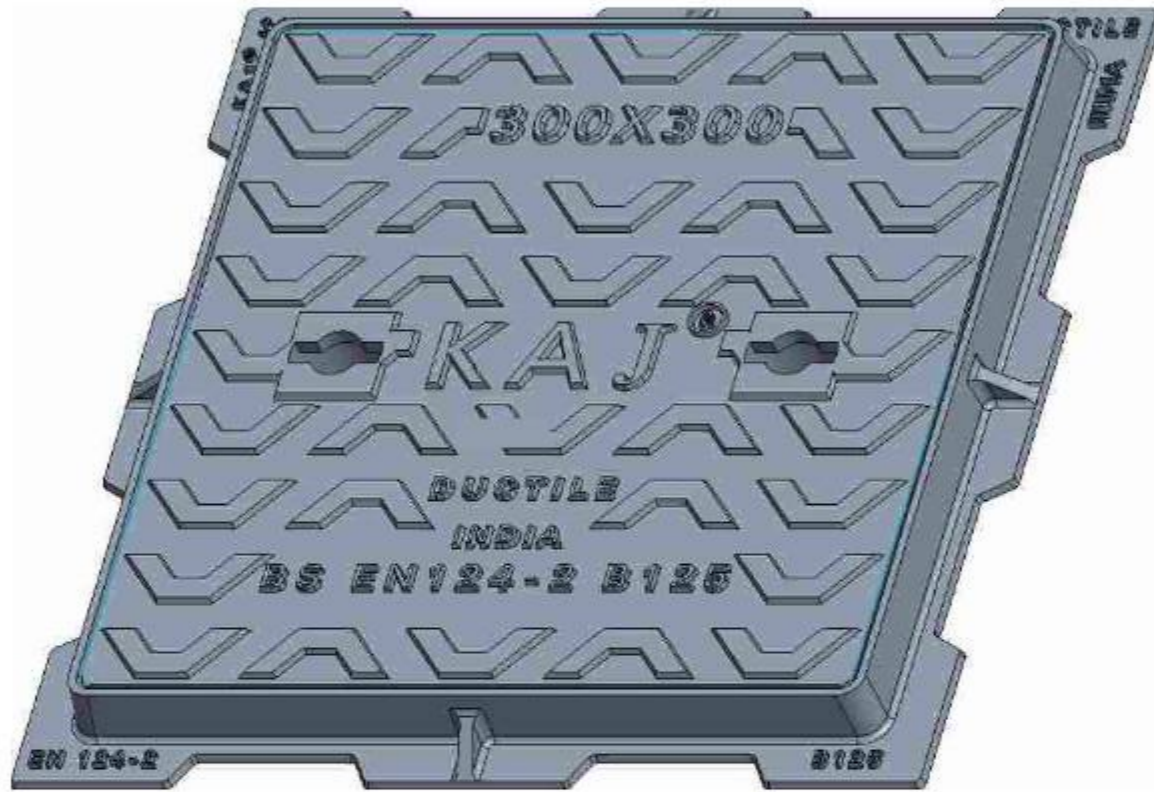

B125 Manhole Covers manufactured to BS-EN 124-2 Compliant skid resistant for high risk location



Anti-flex covers prevent the causes of cover seating wear, eliminating excessive noise and catastrophic failure.



Specially designed cover support geometry reduces movement relative to the frame, minimising seating wear.



Enlarged frame corners help to dissipate, load minimising bearing pressure.



Indexed corners ensure correct orientation first time, every time.



Inspection window allows safe and easy view into chamber.

300X300 X32 B 125 SOLID TOP COVER AND FRAME						
S#	CLEAR OPENING	OVER BASE	TOTAL HEIGHT	LOAD CLASS	FEATURES	KITE MARK
	AxA (MM)	BxB (MM)	H (MM)			
1	300 X 300	450 x 450	32	B- 125	Double Seal/ GRP PROVISION	NO

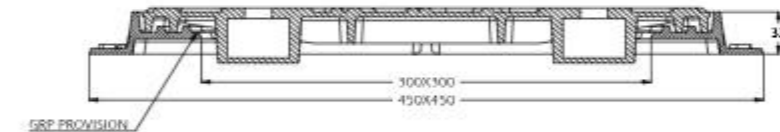
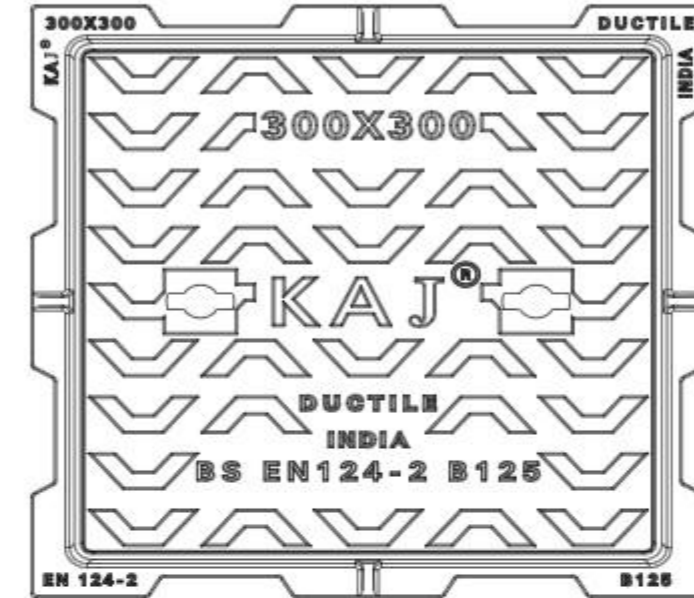

SECTION A-A

FEATURES:

1. Manufactured as per BS EN 124 -2 Design Standard
2. Can also be designed with a concealed locking mechanism for safer access
3. Load achieve before concrete filling
4. Designed to non-rock
5. Can be provisioned for Gasket and GRP seating
6. Custom Marking/ Logos available on request

REV. NO	DATE	MODIFICATION	NAME	DATE	SIGN.	KAJ [®] KAJ BUILDING & CONSTRUCTION MATERIALS WHOLESALE TRADING LLC. <small>Registered Office: Plot Number - 425-B Building Name - ABRAJ CENTRA, Red Street - Dubai Email: info@kajworld.com Website: www.kajworld.com Warehouse: INDUSTRIAL AREA-03 - Madha Street Plot Number: 95, Government Land No. - 345, SHARAJH (RAJ)</small>	
			DRWN. BY:-	T.R.B	20.02.23	DRAWING DESCRIPTION:- 300X300 SOLID TOP B 125 FRAME AND COVER (WITH GRP) COAT:- BLACK BITUMEN SHEET NO:- 1 OF 1 DRG. NO. K-302A	
			CHKD. BY:-	R.Mukharjee	20.02.23		
			APPRD. BY:-	T.R.B	20.02.23		
			MATERIAL:-	DUCTILE IRON EN1563-500/7			
			TOLERANCE:-	ISO 8062 (CT-11)			
			BRAND:-	KAJ			
						LOAD:-	B 125
						SCALE:-	NTS
						ALL DIMENSIONS ARE IN MM.	

300X300X80 D400 RECESS TOP MANHOLE COVER WITH GRP SEALING PROVISION

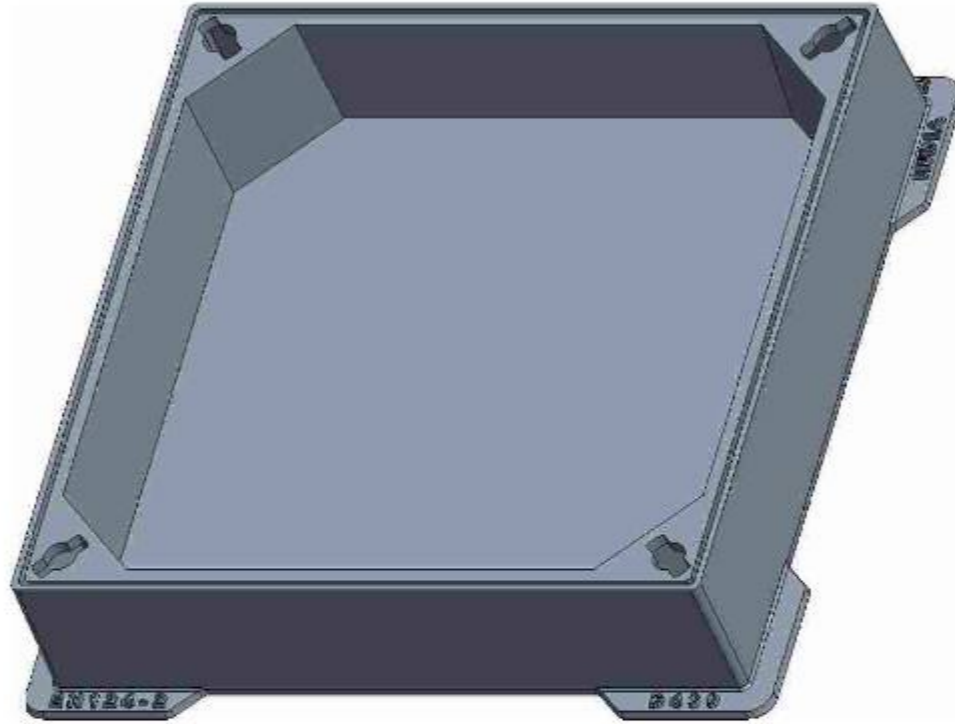

D400 Manhole Covers manufactured to BS-EN 124-2 Compliant skid resistant for high risk location



Anti-flex covers prevent the causes of cover seating wear, eliminating excessive noise and catastrophic failure.



Specially designed cover support geometry reduces movement relative to the frame, minimising seating wear.



Enlarged frame corners help to dissipate, load minimising bearing pressure.



Indexed corners ensure correct orientation first time, every time.



Inspection window allows safe and easy view into chamber.

300 X 300 X 80 RECESS TOP COVER & FRAME D 400

S#	CLEAR OPENING AxA (MM)	OVER BASE BxB (MM)	TOTAL DEPTH H (MM)	RECESSED DEPTH R (MM)	LOAD CLASS	FEATURES	KITE MARK
1	300 X 300	470 x 470	95	80	D - 400	Double Seal/ GRP PROVISION	NO

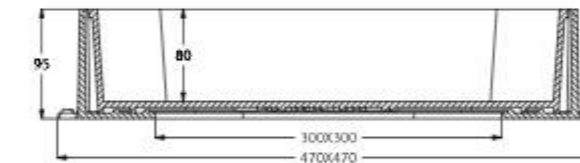
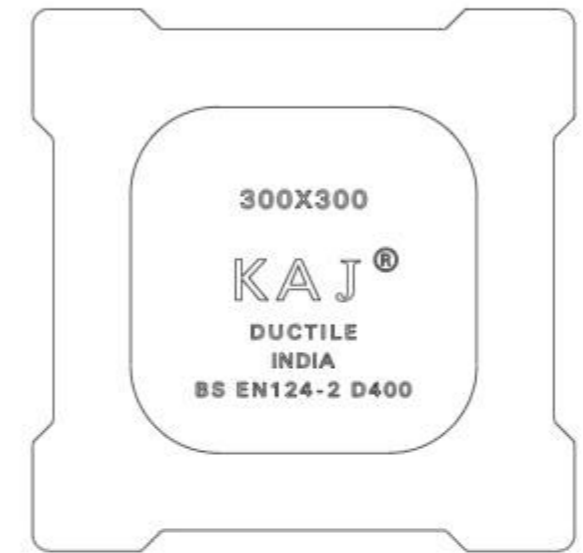
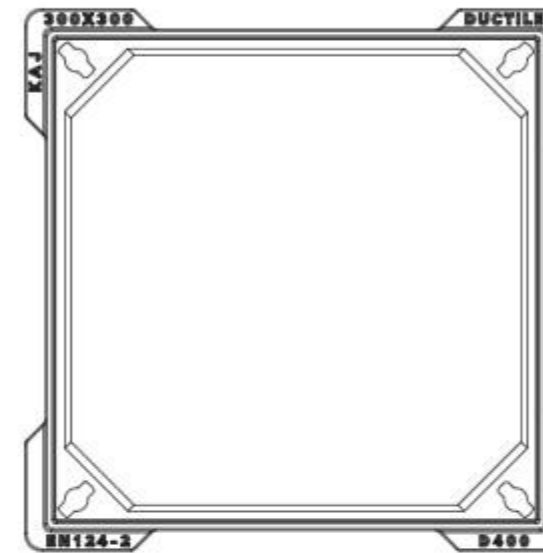

FEATURES:

1. Manufactured as per BS EN 124 -2 Design Standard
2. Can also be designed with a concealed locking mechanism for safer access
3. Load achieve before concrete filling
4. Designed to non-rock
5. Can be provisioned for Gasket and GRP seating
6. Custom Marking/ Logos available on request

REV. NO	DATE	MODIFICATION	NAME	DATE	SIGN.	KAJ® KAJ BUILDING & CONSTRUCTION MATERIALS WHOLESALE TRADING LLC. <small>Registered Office: Plot Number - 125-B Building Name - ARBAJ CENTER, Red Street - Dubai Email: info@kajworld.com Website: www.kajworld.com Warehouse: INDUSTRIAL AREA-43 - Madha Street Plot Number - 105, Government Land No. - 105, SHARAJH (RAJ)</small>
			DRWN. BY:-	T.R.B	20.02.23	
			CHKD. BY:-	R.Mukherjee	20.02.23	
			APPRD. BY:-	T.R.B	20.02.23	
			MATERIAL:-	DUCTILE IRON EN1563-500/7		
			TOLERANCE:-	ISO 8062 (CT-11)		
			BRAND:-	KAJ		
				LOAD:-	D400	
				SCALE:-	NTS	
			ALL DIMENSIONS ARE IN MM.			

300X300X80 B125 RECESS TOP MANHOLE COVER WITH GRP SEALING PROVISION

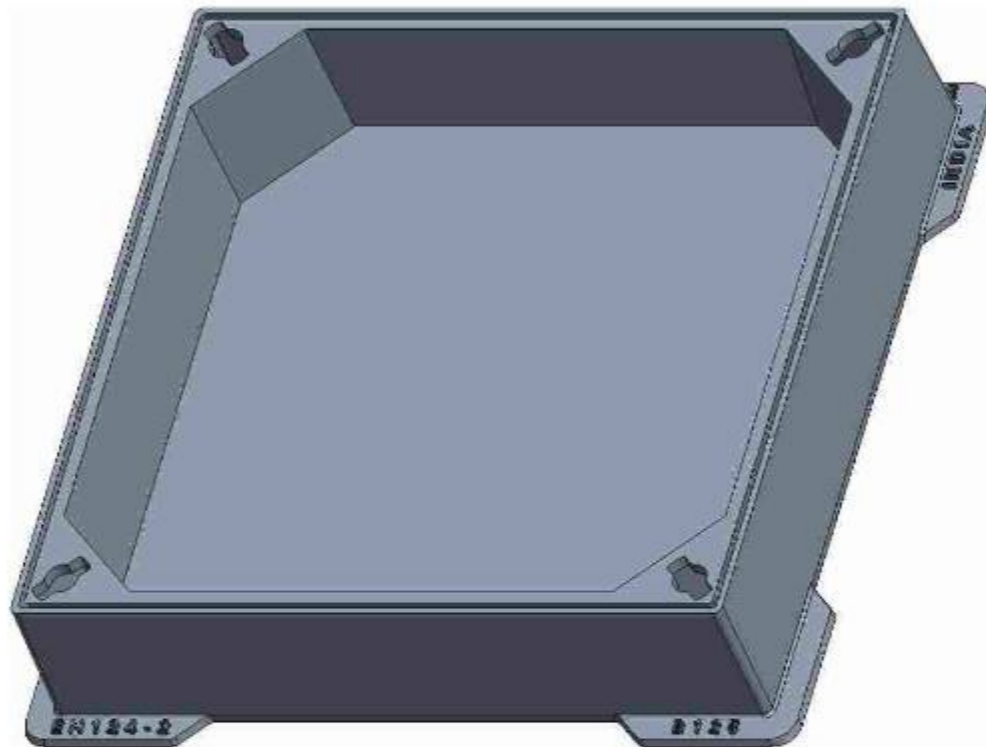

B125 Manhole Covers manufactured to BS-EN 124-2 Compliant skid resistant for high risk location



Anti-flex covers prevent the causes of cover seating wear, eliminating excessive noise and catastrophic failure.



Specially designed cover support geometry reduces movement relative to the frame, minimising seating wear.



Enlarged frame corners help to dissipate, load minimising bearing pressure.



Indexed corners ensure correct orientation first time, every time.



Inspection window allows safe and easy view into chamber.

300 X 300 X 80 RECESS TOP COVER & FRAME B125							
S#	CLEAR OPENING AxA (MM)	OVER BASE BxB (MM)	TOTAL DEPTH H (MM)	RECESSED DEPTH R (MM)	LOAD CLASS	FEATURES	KITE MARK
1	300 X 300	470 x 470	95	80	B-125	Double Seal/ GRP PROVISION	NO

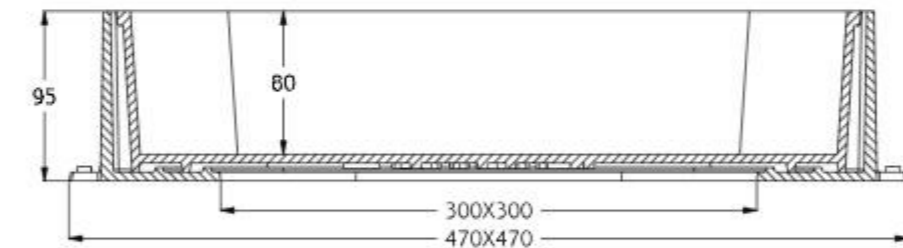
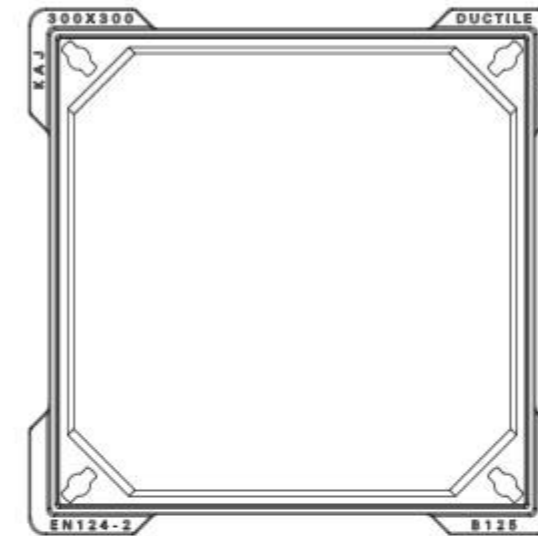

FEATURES:

1. Manufactured as per BS EN 124 -2 Design Standard
2. Can also be designed with a concealed locking mechanism for safer access
3. Load achieve before concrete filling
4. Designed to non-rock
5. Can be provisioned for Gasket and GRP seating
6. Custom Marking/ Logos available on request

REV. NO	DATE	MODIFICATION	NAME	DATE	SIGN.	KAJ® KAJ BUILDING & CONSTRUCTION MATERIALS WHOLESALE TRADING LLC. Regional Office: Plot Number - 137-B Building Name - ARBAJ CENTER, Red Street - Dabur Email : info@kajworld.com Website : www.kajworld.com Warehouse : MEDTAN, AREA-03 -Maha Street Plot Number : 105, Government Land No - 140, SHARAD (BKC)
			DRWN. BY:-	T.R.B	20.02.23	
			CHKD. BY:-	R.Mukherjee	20.02.23	
			APPRD. BY:-	T.R.B	20.02.23	
			MATERIAL:-	DUCTILE IRON EN1563-500/7		
			TOLERANCE:-	ISO 8062 (CT-11)		
			BRAND:-	KAJ		
				LOAD:-	B 125	
				SCALE:-	NTS	
				ALL DIMENSIONS ARE IN MM.		

300X300X50 D400 GULLY GRATE MANHOLE COVER

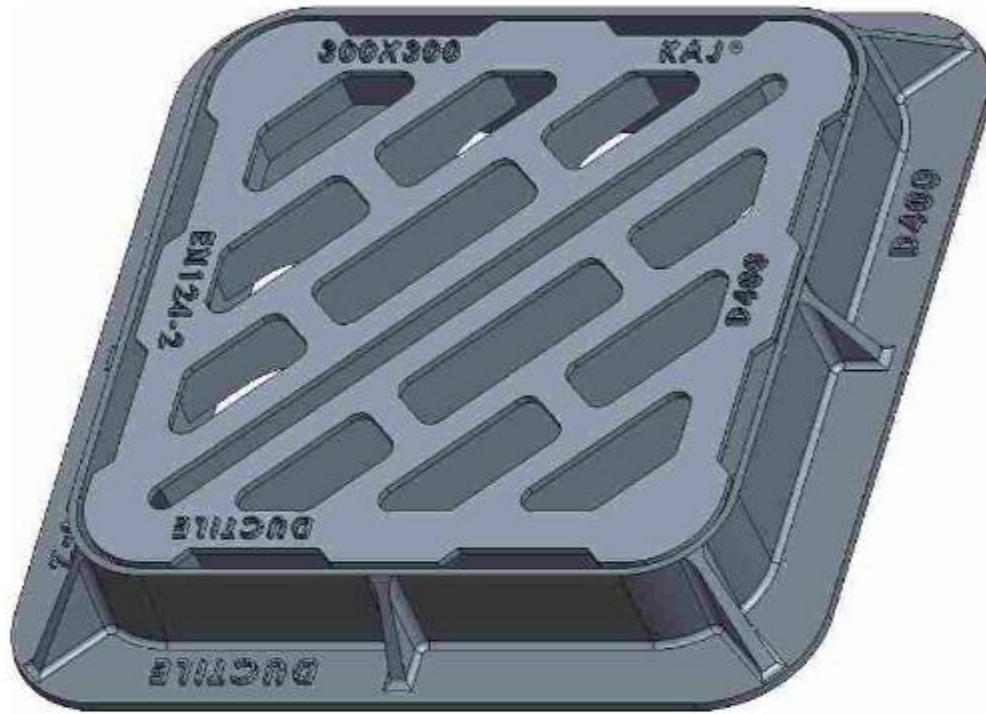

D400 Chanel Grating manufactured to BS-EN 124-2 Compliant skid resistant for high risk location



Anti-flex covers prevent the causes of cover seating wear, eliminating excessive noise and catastrophic failure.



Specially designed cover support geometry reduces movement relative to the frame, minimising seating wear.



Enlarged frame corners help to dissipate, load minimising bearing pressure.



Indexed corners ensure correct orientation first time, every time.



Inspection window allows safe and easy view into chamber.

300X300 X50 D400 GULLY GRATE						
S#	CLEAR OPENING AxA (MM)	OVER BASE BxB (MM)	TOTAL HEIGHT H (MM)	LOAD CLASS	FEATURES	KITE MARK
1	300 X 300	380 x 380	50	D - 400	Double Seal/ GRP PROVISION	NO

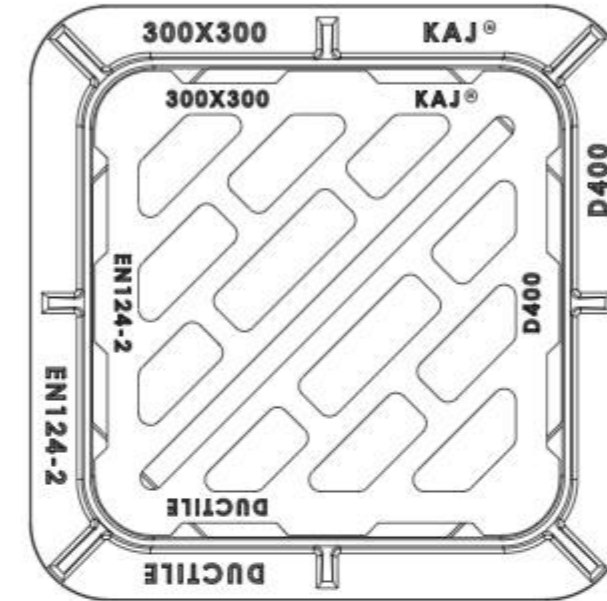

TOP VIEW

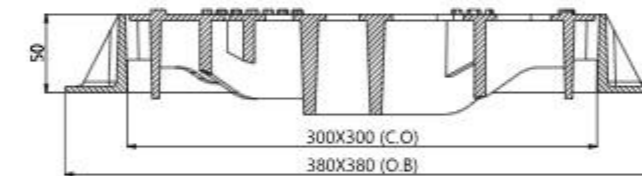

SECTION VIEW

FEATURES:

1. Manufactured as per BS EN 124 -2 Design Standard
2. Can also be designed with a concealed locking mechanism for safer access
3. Load achieve before concrete filling
4. Designed to non-rock
5. Can be provisioned for Gasket and GRP seating
6. Custom Marking/ Logos available on request

REV. NO	DATE	MODIFICATION	NAME	DATE	SIGN.	KAJ® KAJ BUILDING & CONSTRUCTION MATERIALS WHOLESALE TRADING LLC. Registered Office Plot Number : 125-B Building Name : JBRRAI CENTER, Red Street - Dubai Email : info@kajworld.com Website : www.kajworld.com Warehouse : MEDINNA, AREA-03 -Mulla Street Plot Number : 105, Government Land No - 140, SHARAJ (UAE)
			DRWN. BY:-	T.R.B	20.02.23	
			CHKD. BY:-	R.Mukherjee	20.02.23	
			APPRD. BY:-	T.R.B	20.02.23	
			MATERIAL:-	DUCTILE IRON EN1563-500/7		
			TOLERANCE:-	ISO 8062 (CT-11)		
			BRAND:-	KAJ		
				LOAD:-	D400	
				SCALE:-	NTS	
			ALL DIMENSIONS ARE IN MM.			

450X450X70 D400 SOLID TOP MANHOLE COVER WITH GRP SEALING PROVISION

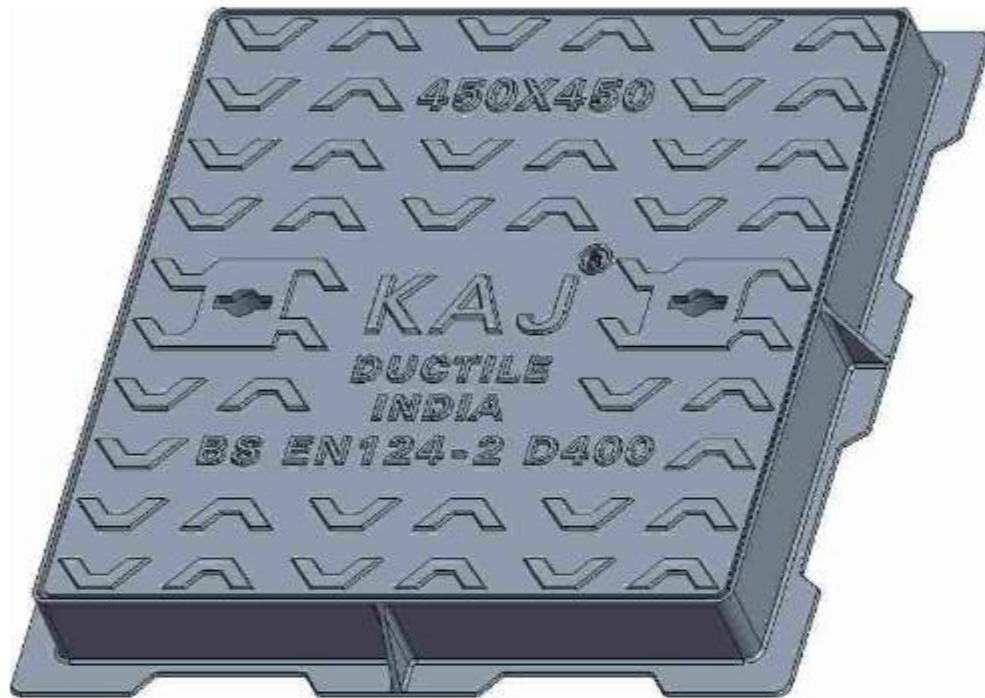

D400 Manhole Covers manufactured to BS-EN 124-2 Compliant skid resistant for high risk location



Anti-flex covers prevent the causes of cover seating wear, eliminating excessive noise and catastrophic failure.



Specially designed cover support geometry reduces movement relative to the frame, minimising seating wear.



Enlarged frame corners help to dissipate, load minimising bearing pressure.



Indexed corners ensure correct orientation first time, every time.



Inspection window allows safe and easy view into chamber.

450X450X70 D 400 SOLID TOP COVER AND FRAME						
S#	CLEAR OPENING AxA (MM)	OVER BASE BxB (MM)	TOTAL HEIGHT H (MM)	LOAD CLASS	FEATURES	KITE MARK
1	450 X 450	618 x 618	70	D- 400	Double Seal/ GRP PROVISION	NO

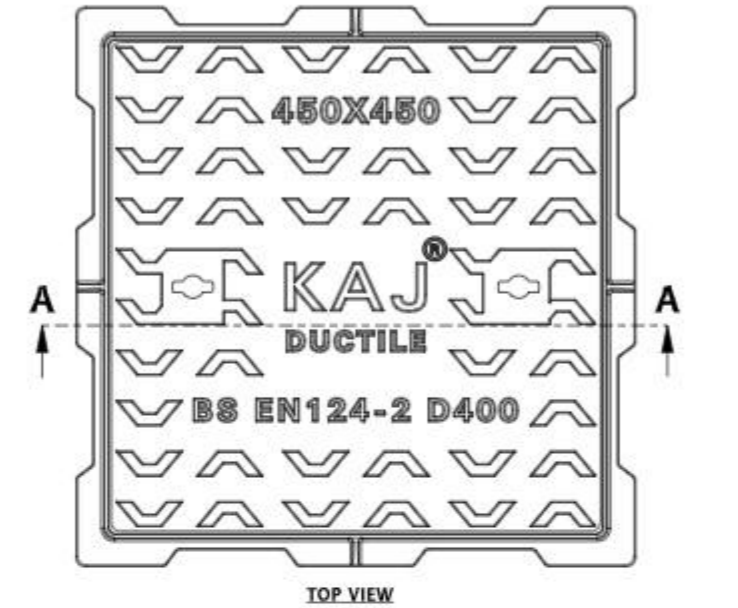

TOP VIEW

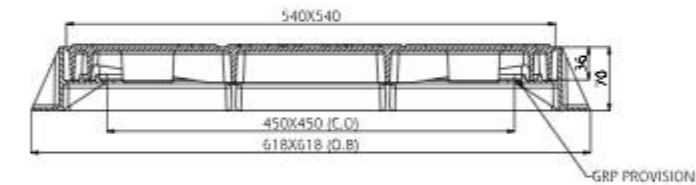

FRONT VIEW
SECTION "A - A"

FEATURES:

1. Manufactured as per BS EN 124 -2 Design Standard
2. Can also be designed with a concealed locking mechanism for safer access
3. Load achieve before concrete filling
4. Designed to non-rock
5. Can be provisioned for Gasket and GRP seating
6. Custom Marking/ Logos available on request

REV. NO	DATE	MODIFICATION	NAME	DATE	SIGN.	KAJ® KAJ BUILDING & CONSTRUCTION MATERIALS WHOLESALE TRADING LLC. Registered Office: Plot Number: 123-0 Building Name: ABRA CENTER, Red Street - Dubai E-mail: info@kajworld.com Website: www.kajworld.com Warehouse: INDUSTRIAL AREA-01- Madha Street Plot Number: 105, Government Land No. - 145, SHARJAH (UAE)	
			DRWN. BY:-	T.R.B	20.02.23	DRAWING DESCRIPTION:- 450X450 SOLID TOP D400 FRAME AND COVER (WITH GRP)	
			CHKD. BY:-	R.Mukherjee	20.02.23		
			APPRD. BY:-	T.R.B	20.02.23		
			MATERIAL:- DUCTILE IRON EN1563-500/7			COAT:- BLACK BITUMEN	
			TOLERANCE:- ISO 8062 (CT-11)				
			BRAND:- KAJ			SHEET NO:- 1 OF 1	
			LOAD:- D400 SCALE:- NTS				
			ALL DIMENSIONS ARE IN MM.			DRG. NO. K-401A	

450X450X70 B125 SOLID TOP MANHOLE COVER WITH GRP SEALING PROVISION

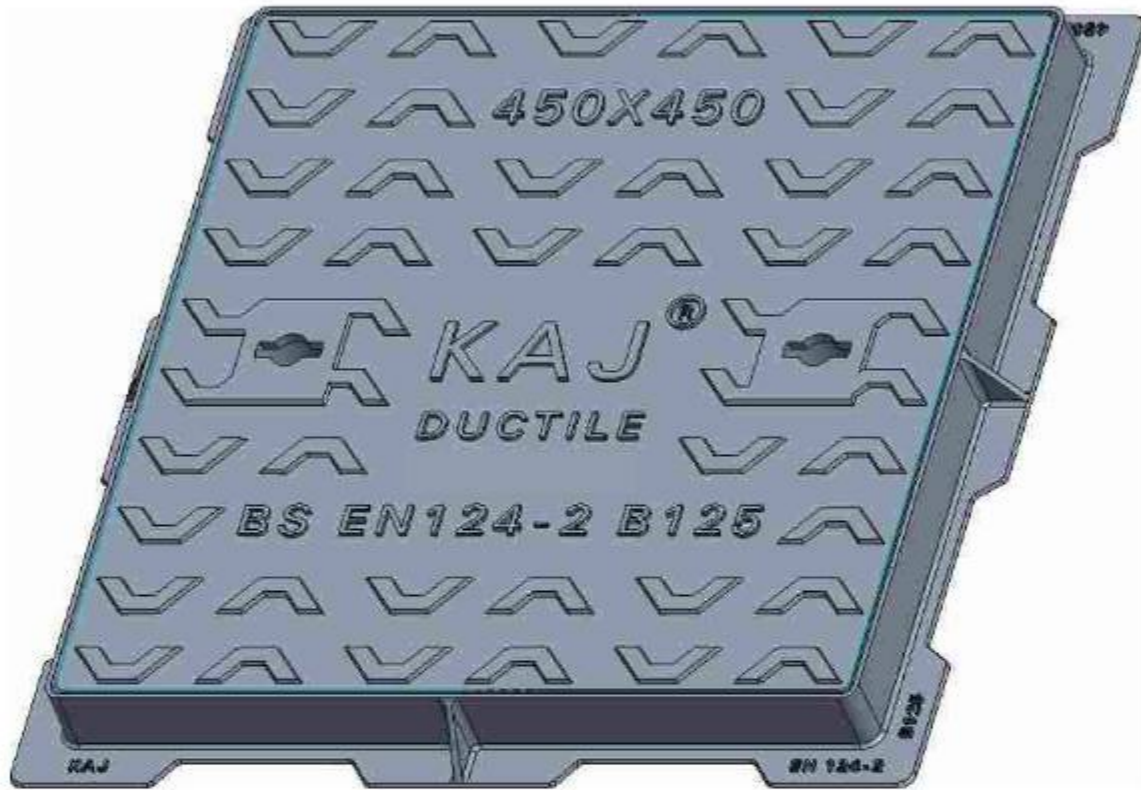

B125 Manhole Covers manufactured to BS-EN 124-2 Compliant skid resistant for high risk location



Anti-flex covers prevent the causes of cover seating wear, eliminating excessive noise and catastrophic failure.



Specially designed cover support geometry reduces movement relative to the frame, minimising seating wear.



Enlarged frame corners help to dissipate, load minimising bearing pressure.



Indexed corners ensure correct orientation first time, every time.



Inspection window allows safe and easy view into chamber.

450X450X70 B 125 SOLID TOP COVER AND FRAME

S#	CLEAR OPENING	OVER BASE	TOTAL HEIGHT	LOAD CLASS	FEATURES
	AxA (MM)	BxB (MM)	H (MM)		
1	450 X 450	618 x 618	70	B- 125	Double Seal / GRP PROVISION

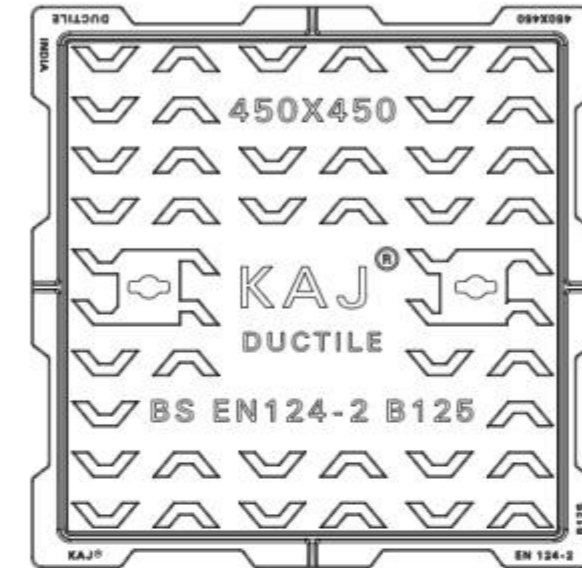

SECTION A-A

FEATURES:

1. Manufactured as per BS EN 124 -2 Design Standard
2. Can also be designed with a concealed locking mechanism for safer access
3. Load achieve before concrete filling
4. Designed to non-rock
5. Can be provisioned for Gasket and GRP seating
6. Custom Marking/ Logos available on request

REV. NO	DATE	MODIFICATION	NAME	DATE	SIGN.	KAJ[®] KAJ BUILDING MATERIAL PVT. LTD. <small>Registered Office: Plot Number: 107-2 Building Name: ARRA/CRIDA, 1st Stage - 5th Mile 2nd Mile, Old Airport Road, Bangalore - 560026 Website: www.kajworld.com Plot Number: 107, Government Layout No. 146, 5th Stage (5th Mile)</small>
			DRWN. BY:-	T.R.B	20.02.23	
			CHKD. BY:-	R.Mukherjee	20.02.23	
			APPRD. BY:-	T.R.B	20.02.23	
			MATERIAL:-	DUCTILE IRON EN1563-500/7		
			TOLERANCE:-	ISO 8062 (CT-1.1)		
			BRAND:-	KAJ		
				LOAD:-	B 125	
				SCALE:-	NTS	
			ALL DIMENSIONS ARE IN MM.			

450X450X80 D400 RECESS TOP MANHOLE COVER WITH GRP SEALING PROVISION

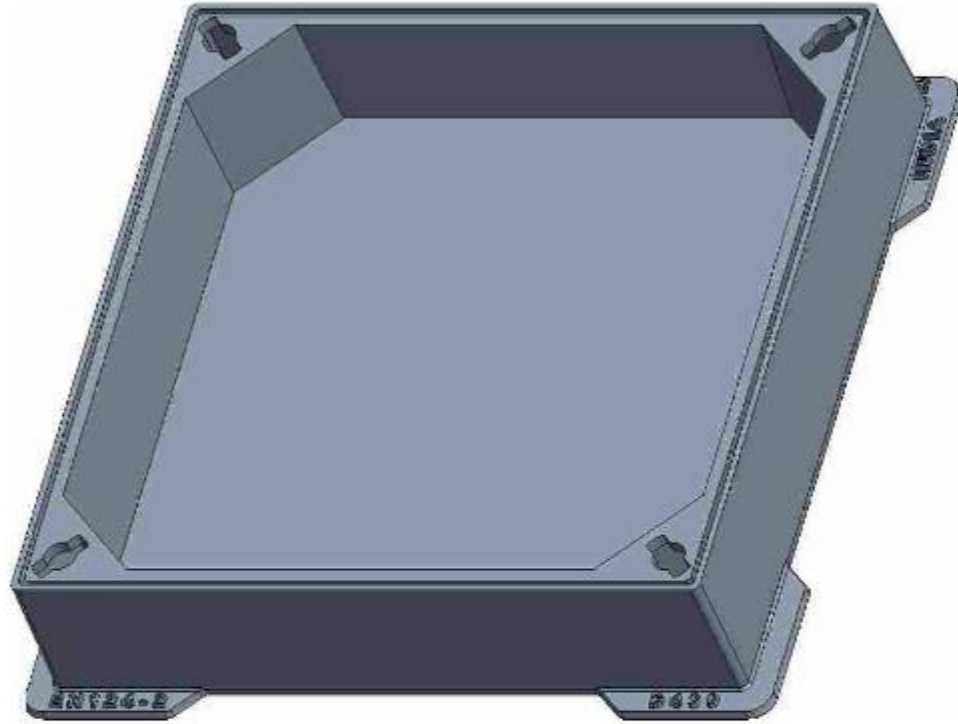

D400 Manhole Covers manufactured to BS-EN 124-2 Compliant skid resistant for high risk location



Anti-flex covers prevent the causes of cover seating wear, eliminating excessive noise and catastrophic failure.



Specially designed cover support geometry reduces movement relative to the frame, minimising seating wear.



Enlarged frame corners help to dissipate, load minimising bearing pressure.



Indexed corners ensure correct orientation first time, every time.



Inspection window allows safe and easy view into chamber.

450 X 450 X 80 RECESS TOP COVER & FRAME D 400

S#	CLEAR OPENING AxA (MM)	OVER BASE BxB (MM)	TOTAL DEPTH H (MM)	RECESSED DEPTH R (MM)	LOAD CLASS	FEATURES	KITE MARK
1	450 X 450	615 x 615	100	80	D - 400	Double Seal/ GRP PROVISION	NO

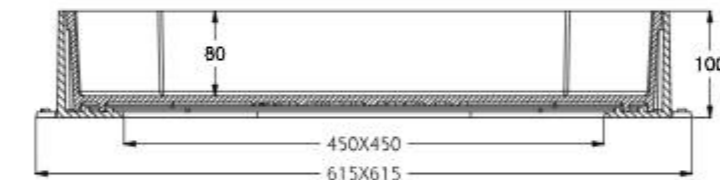
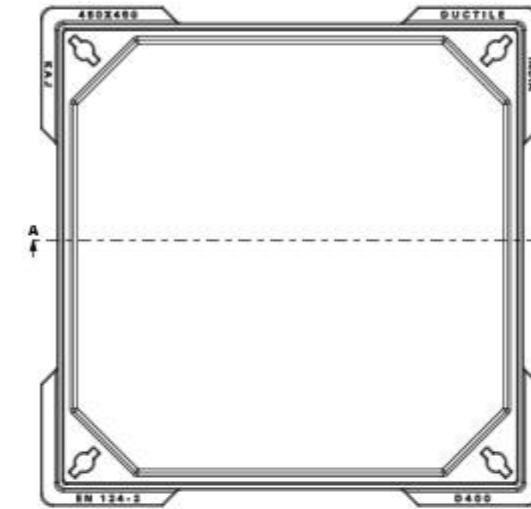

SECTION A-A

FEATURES:

1. Manufactured as per BS EN 124 -2 Design Standard
2. Can also be designed with a concealed locking mechanism for safer access
3. Load achieve before concrete filling
4. Designed to non-rock
5. Can be provisioned for Gasket and GRP seating
6. Custom Marking/ Logos available on request

REV. NO	DATE	MODIFICATION	NAME	DATE	SIGN.	KAJ® KAJ BUILDING MATERIAL PVT. LTD. <small>Registered Office: Plot Number: 107-D Building Water: 400/12, 10th Street - 600011 Email: info@kajworld.com Website: www.kajworld.com Warehouse: RECESSED AREA 17, Madhav Street Plot Number: 107, Government Land No. 146, 600009 (SR)</small>
			DRWN. BY:- T.R.B	20.02.23		
			CHKD. BY:- R.Mukherjee	20.02.23		COAT:- BLACK BITUMEN SHEET NO:- 1 OF 1 DRG. NO. K-403 A
			APPRD. BY:- T.R.B	20.02.23		
			MATERIAL:- DUCTILE IRON EN1563-500/7			
			TOLERANCE:- ISO 8062 (CT-11)			
			BRAND:- KAJ			
			LOAD:- D400 SCALE:- NTS			
			ALL DIMENSIONS ARE IN MM.			

450X450X80 B125 RECESS TOP MANHOLE COVER WITH GRP SEALING PROVISION

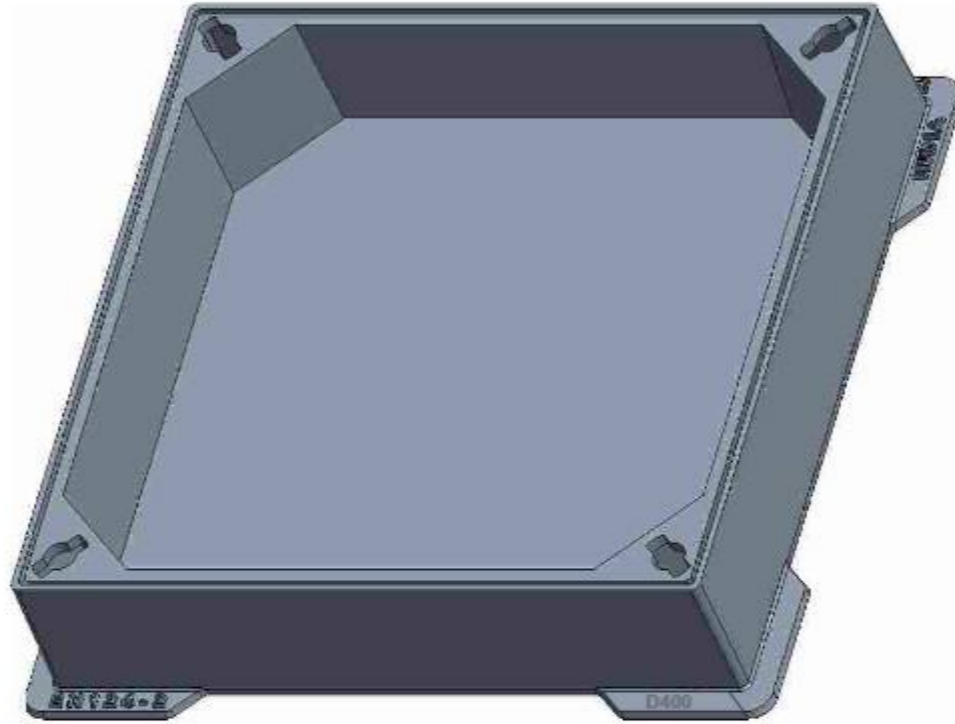

B125 Manhole Covers manufactured to BS-EN 124-2 Compliant skid resistant for high risk location



Anti-flex covers prevent the causes of cover seating wear, eliminating excessive noise and catastrophic failure.



Specially designed cover support geometry reduces movement relative to the frame, minimising seating wear.



Enlarged frame corners help to dissipate, load minimising bearing pressure.



Indexed corners ensure correct orientation first time, every time.



Inspection window allows safe and easy view into chamber.

450 X 450 X 80 RECESS TOP COVER & FRAME B125

S#	CLEAR OPENING AxA (MM)	OVER BASE BxB (MM)	TOTAL DEPTH H (MM)	RECESSED DEPTH R (MM)	LOAD CLASS	FEATURES	KITE MARK
1	450 X 450	615 x 615	100	80	B-125	Double Seal/ GRP PROVISION	NO

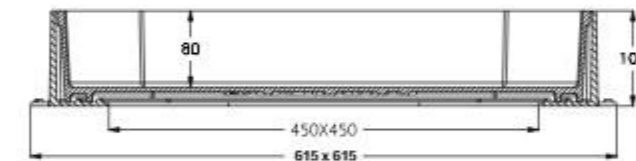
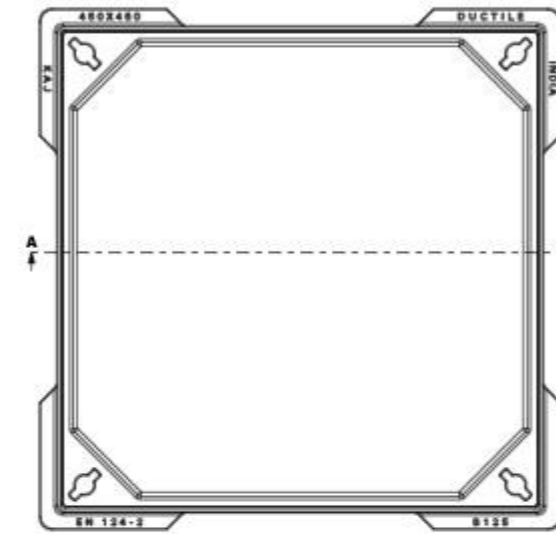

SECTION A-A

FEATURES:

1. Manufactured as per BS EN 124 -2 Design Standard
2. Can also be designed with a concealed locking mechanism for safer access
3. Load achieve before concrete filling
4. Designed to non-rock
5. Can be provisioned for Gasket and GRP seating
6. Custom Marking/ Logos available on request

REV. NO	DATE	MODIFICATION	NAME	DATE	SIGN.	KAJ® KAJ BUILDING & CONSTRUCTION MATERIALS WHOLESALE TRADING LLC Registered Office: Plot Number: 123-D Building Name: ABRA CENTER, Red Street - Dubai E-mail: info@kajworld.com Website: www.kajworld.com Warehouse: INDUSTRIAL AREA-03 - Mulla Street Plot Number: 100, Government Land No. : 140, Sharjah (UAE)
			DRWN. BY:-	T.R.B	20.02.23	
			CHKD. BY:-	R.Mukherjee	20.02.23	
			APPRD. BY:-	T.R.B	20.02.23	
			MATERIAL:-	DUCTILE IRON EN1563-500/7		
			TOLERANCE:-	ISO 8062 (CT-11)		
			BRAND:-	KAJ		
				LOAD:-	B 125	
				SCALE:-	NTS	
			ALL DIMENSIONS ARE IN MM.			

450X450X80 D400 GULLY GRATE MANHOLE COVER



B125 Manhole Covers manufactured to BS-EN 124-2 Compliant skid resistant for high risk location



Anti-flex covers prevent the causes of cover seating wear, eliminating excessive noise and catastrophic failure.



Specially designed cover support geometry reduces movement relative to the frame, minimising seating wear.



Enlarged frame corners help to dissipate, load minimising bearing pressure.



Indexed corners ensure correct orientation first time, every time.



Inspection window allows safe and easy view into chamber.

450X450X80 D400 GULLY GRATE D 400						
S#	CLEAR OPENING AxA (MM)	OVER BASE BxB (MM)	TOTAL HEIGHT H (MM)	LOAD CLASS	FEATURES	KITE MARK
1	450 X 450	700 x 700	80	D - 400	Single Seal	NO

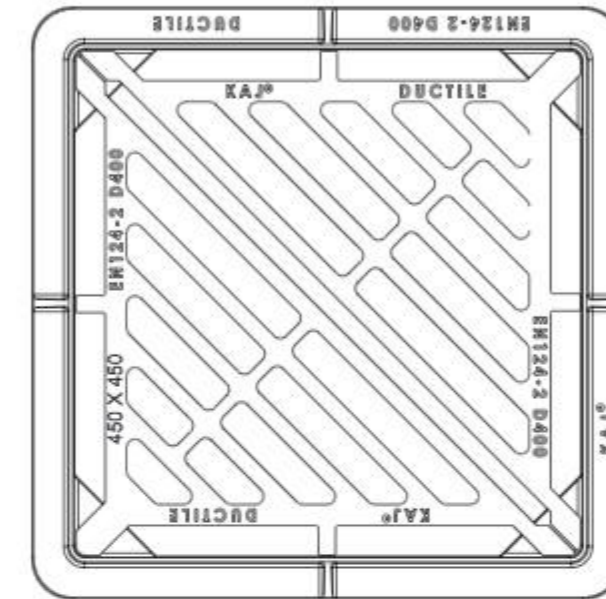

TOP VIEW

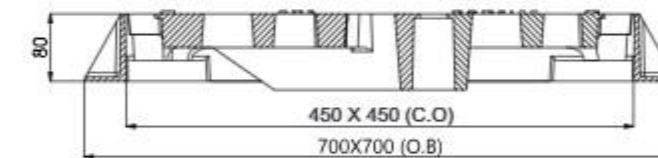

SECTION VIEW

FEATURES:

1. Manufactured as per BS EN 124 -2 Design Standard
2. Can also be designed with a concealed locking mechanism for safer access
3. Load achieve before concrete filling
4. Designed to non-rock
5. Can be provisioned for Gasket and GRP seating
6. Custom Marking/ Logos available on request

REV. NO	DATE	MODIFICATION	NAME	DATE	SIGN.	KAJ® KAJ BUILDING & CONSTRUCTION MATERIALS WHOLESALE TRADING LLC. Registered Office: Plot Number - 137-D Building Name - ABRA CENTER, Red Street - Dubai E-mail: info@kajworld.com Website: www.kajworld.com Warehouse: INDUSTRIAL AREA-43 - Mulla Street Plot Number: 100, Government Land No. - 140, Sharjah (UAE)
			DRWN. BY:-	T.R.B	20.02.23	
			CHKD. BY:-	R.Mukherjee	20.02.23	
			APPRD. BY:-	T.R.B	20.02.23	
			MATERIAL:-	DUCTILE IRON EN1563-500/7		
			TOLERANCE:-	ISO 8062 (CT-11)		
			BRAND:-	KAJ		
				LOAD:-	D400	
				SCALE:-	NTS	
			ALL DIMENSIONS ARE IN MM.			

600X600X100 D 400 SOLID TOP MANHOLE COVER WITH GRP SEALING PROVISION

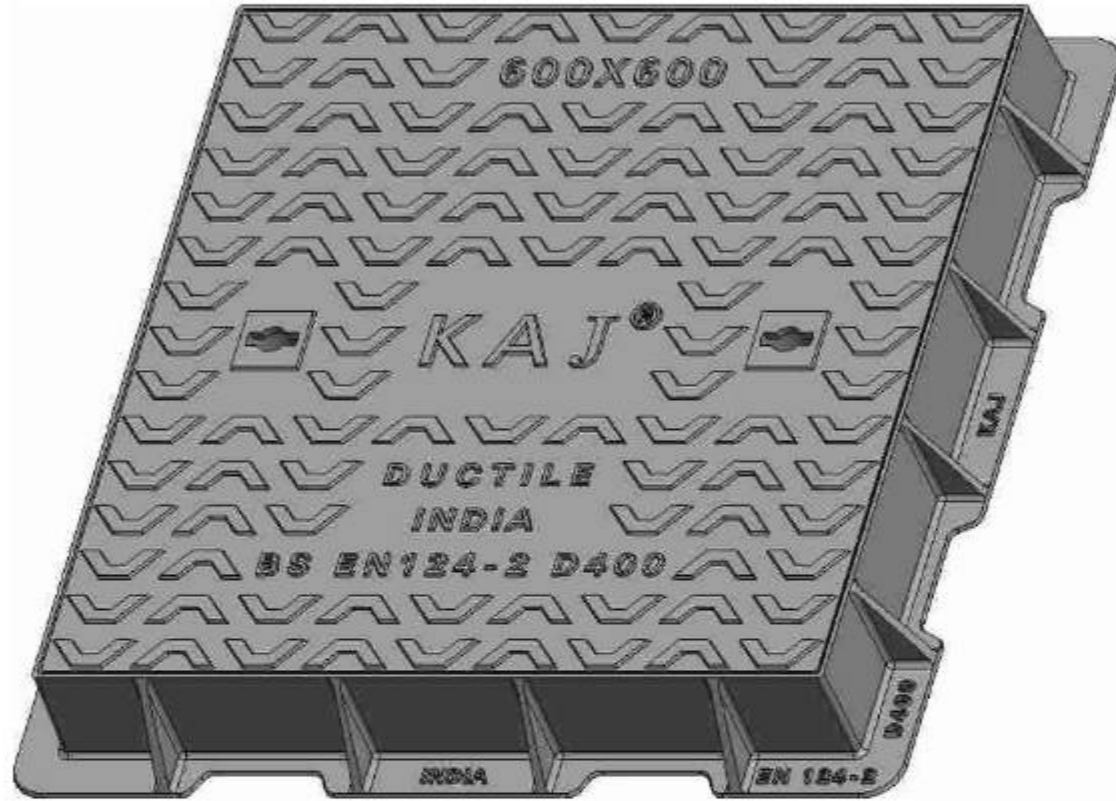

D400 Manhole Covers manufactured to BS-EN 124-2 Compliant skid resistant for high risk location



Anti-flex covers prevent the causes of cover seating wear, eliminating excessive noise and catastrophic failure.



Specially designed cover support geometry reduces movement relative to the frame, minimising seating wear.



Enlarged frame corners help to dissipate, load minimising bearing pressure.



Indexed corners ensure correct orientation first time, every time.



Inspection window allows safe and easy view into chamber.

600X600X100 D 400 SOLID TOP COVER AND FRAME						
S#	CLEAR OPENING	OVER BASE	TOTAL HEIGHT	LOAD CLASS	FEATURES	KITE MARK
	AxA (MM)	BxB (MM)	H (MM)			
1	600 X 600	780 x 780	100	D- 400	Double Seal/ GRP PROVISION	NO

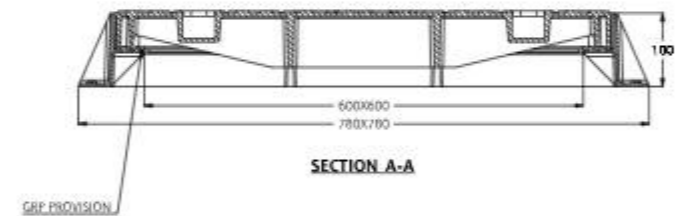

FEATURES:

1. Manufactured as per BS EN 124 -2 Design Standard
2. Can also be designed with a concealed locking mechanism for safer access
3. Load achieve before concrete filling
4. Designed to non-rock
5. Can be provisioned for Gasket and GRP seating
6. Custom Marking/ Logos available on request

REV. NO	DATE	MODIFICATION	NAME	DATE	SIGN.	KAJ® KAJ BUILDING & CONSTRUCTION MATERIALS WHOLESALE TRADING LLC. <small>Registered Office: Plot Number: 611/10 Building Name: ABRAU CENTER, Red Street - Dubai Email : info@kajworld.com Website : www.kajworld.com Warehouse: INDUSTRIAL AREA-C1- Madha Street Plot Number : 104, Government Land No. : 103, SARAJAI (RAJ)</small>
			DRWN. BY:-	T.R.B	20.02.23	
			CHKD. BY:-	R.Mukherjee	20.02.23	
			APPRD. BY:-	T.R.B	20.02.23	
			MATERIAL:- DUCTILE IRON EN1563-500/7			
			TOLERANCE:- ISO 8062 (CT-11)			
			BRAND:- KAJ			
				LOAD:- D400		
				SCALE:- NTS		
			ALL DIMENSIONS ARE IN MM.			

HINGED MULTI-PART TRIANGULAR COVER & FRAME

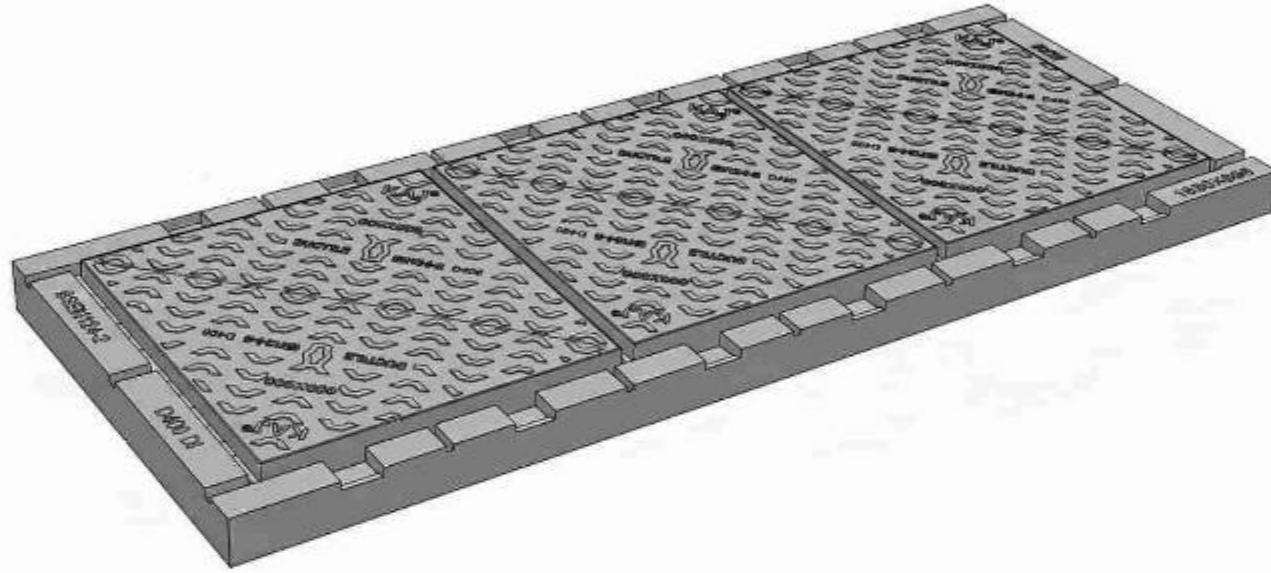

HINGED MULTI-PART TRIANGULAR COVER & FRAME						
S#	CLEAR OPENING AxA (MM)	OVER BASE BxB (MM)	TOTAL HEIGHT H (MM)	LOAD CLASS	FEATURES	KITE MARK
1	1830X696	1984x850	160	D- 400	Multi-Leaf Hinged & Locable Cover	NO

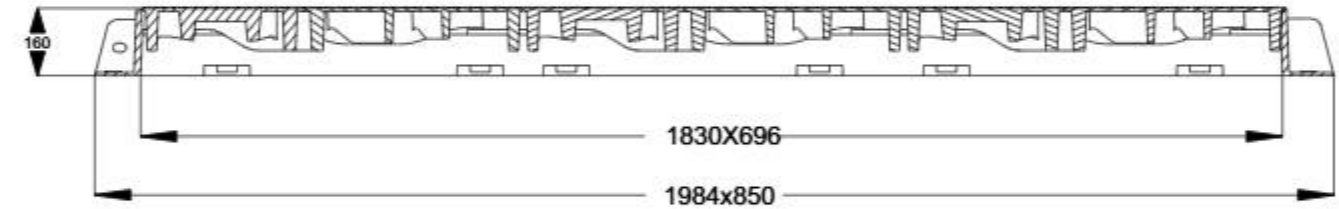
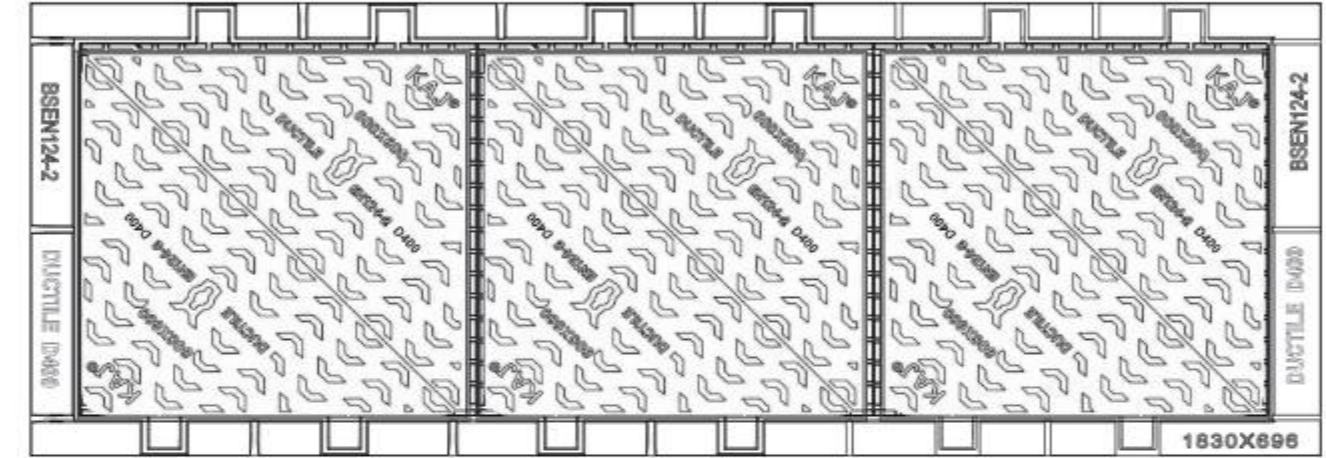

D400 Manhole Covers manufactured to BS-EN 124-2 Compliant skid resistant for high risk location



Anti-flex covers prevent the causes of cover seating wear, eliminating excessive noise and catastrophic failure.



Specially designed cover support geometry reduces movement relative to the frame, minimising seating wear.



Enlarged frame corners help to dissipate, load minimising bearing pressure.



Indexed corners ensure correct orientation first time, every time.



Inspection window allows safe and easy view into chamber.

FEATURES:

1. Manufactured as per BS EN 124 -2 Design Standard
2. Can also be designed with a concealed locking mechanism for safer access
3. Load achieve before concrete filling
4. Designed to non-rock
5. Can be provisioned for Gasket and GRP seating
6. Custom Marking/ Logos available on request

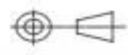
REV. NO	DATE	MODIFICATION	NAME	DATE	SIGN.	KAJ[®] KAJ BUILDING & CONSTRUCTION MATERIALS WHOLESALE TRADING LLC. <small>Registered Office: Plot Number: 6110 Building Name: ABRAU CENTER, Red Street - Dubai Email: info@kajworld.com Website: www.kajworld.com Warehouse: INDUSTRIAL AREA C-1, Mulla Street Plot Number: 104, Government Land No.: 103, SHARAJH (UAE)</small>
			DRWN. BY:-	T.R.B	20.02.23	
			CHKD. BY:-	R.Mukherjee	20.02.23	
			APPRD. BY:-	T.R.B	20.02.23	
			MATERIAL:- DUCTILE IRON EN1563-500/7			
			TOLERANCE:- ISO 8062 (CT-11)			
			BRAND:- KAJ			
			 LOAD:- D400 SCALE:- NTS			
			ALL DIMENSIONS ARE IN MM.			

SOLID TOP DOUBLE TRIANGULAR COVER & FRAME

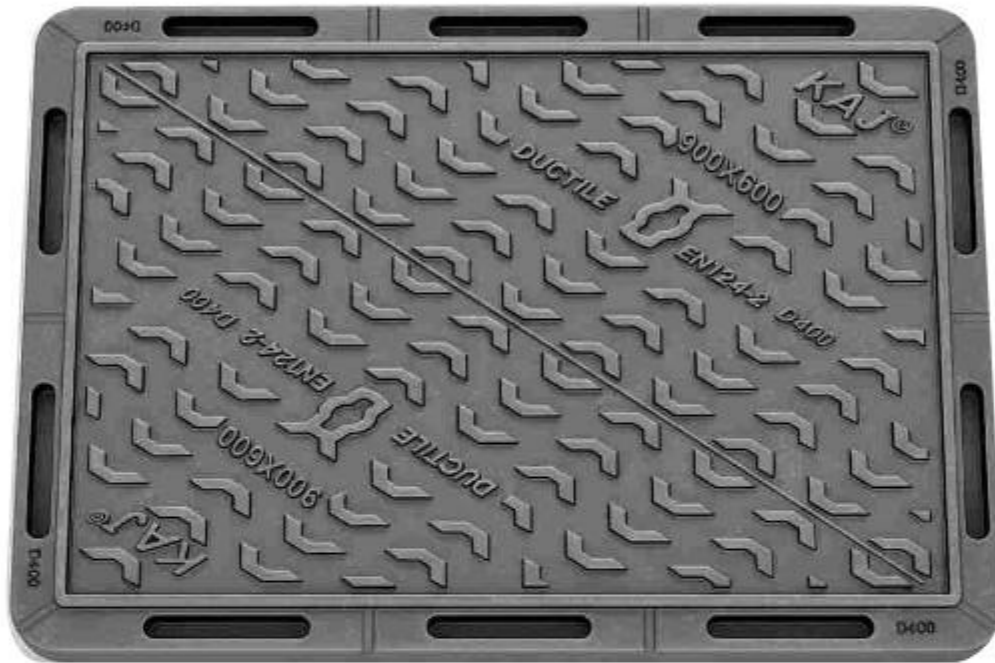

D400 Manhole Covers manufactured to BS-EN 124-2 Compliant skid resistant for high risk location



Anti-flex covers prevent the causes of cover seating wear, eliminating excessive noise and catastrophic failure.



Specially designed cover support geometry reduces movement relative to the frame, minimising seating wear.



Enlarged frame corners help to dissipate, load minimising bearing pressure.



Indexed corners ensure correct orientation first time, every time.



Inspection window allows safe and easy view into chamber.

SOLID TOP DOUBLE TRIANGULAR COVER & FRAME						
S#	CLEAR OPENING AxA (MM)	OVER BASE BxB (MM)	TOTAL HEIGHT H (MM)	LOAD CLASS	FEATURES	KITE MARK
1	900 X 600	1040 X 740	100	D- 400	Bolted Cover Seal Provision	NO

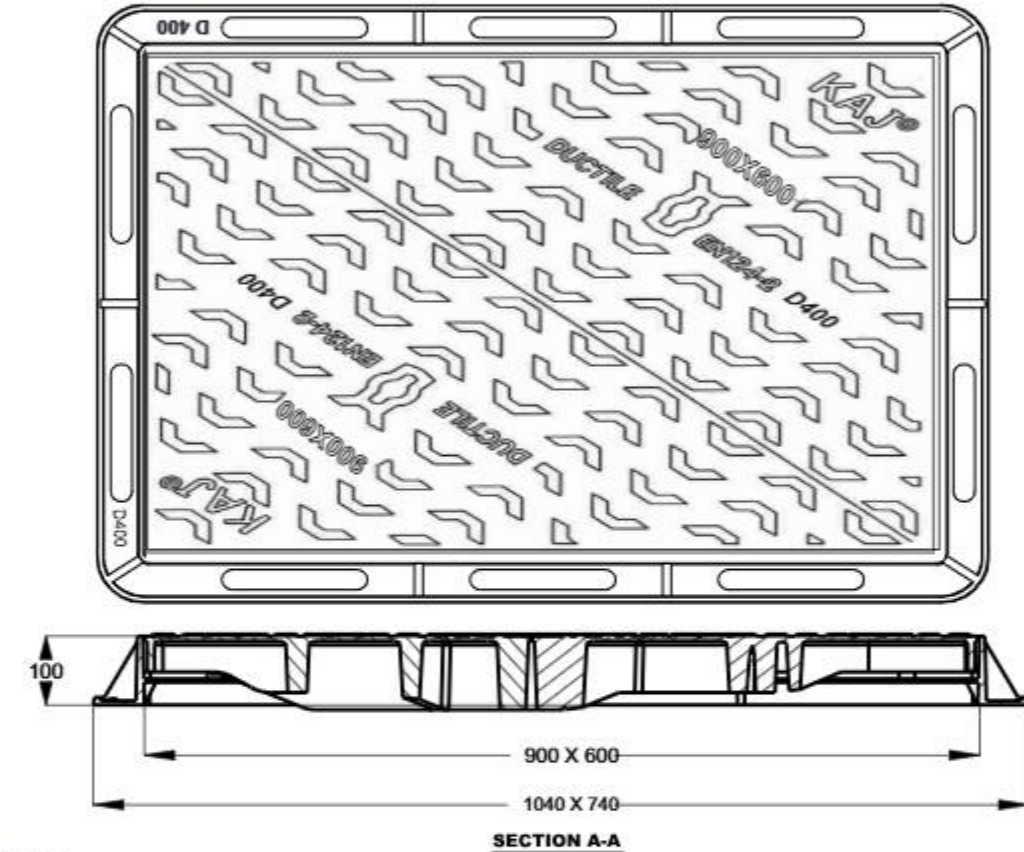

FEATURES:

1. Manufactured as per BS EN 124 -2 Design Standard
2. Can also be designed with a concealed locking mechanism for safer access
3. Load achieve before concrete filling
4. Designed to non-rock
5. Can be provisioned for Gasket and GRP seating
6. Custom Marking/ Logos available on request

REV. NO	DATE	MODIFICATION	NAME	DATE	SIGN.	KAJ® KAJ BUILDING & CONSTRUCTION MATERIALS WHOLESALE TRADING LLC. <small>Registered Office: Plot Number: 6110 Building Name: ABRAU CENTER, Red Street - Dubai Email: info@kajworld.com Website: www.kajworld.com Warehouse: INDUSTRIAL AREA C-1, Mulla Street Plot Number: 104, Government Land No.: 103, SHARAJH (UAE)</small>
			DRWN. BY:-	T.R.B	20.02.23	
			CHKD. BY:-	R.Mukherjee	20.02.23	
			APPRD. BY:-	T.R.B	20.02.23	
			MATERIAL:-	DUCTILE IRON EN1563-500/7		
			TOLERANCE:-	ISO 8062 (CT-11)		
			BRAND:-	KAJ		
				LOAD:-	D400	
				SCALE:-	NTS	
				ALL DIMENSIONS ARE IN MM.		

600X600X50 D 400 SOLID TOP MANHOLE COVER WITH GRP SEALING PROVISION

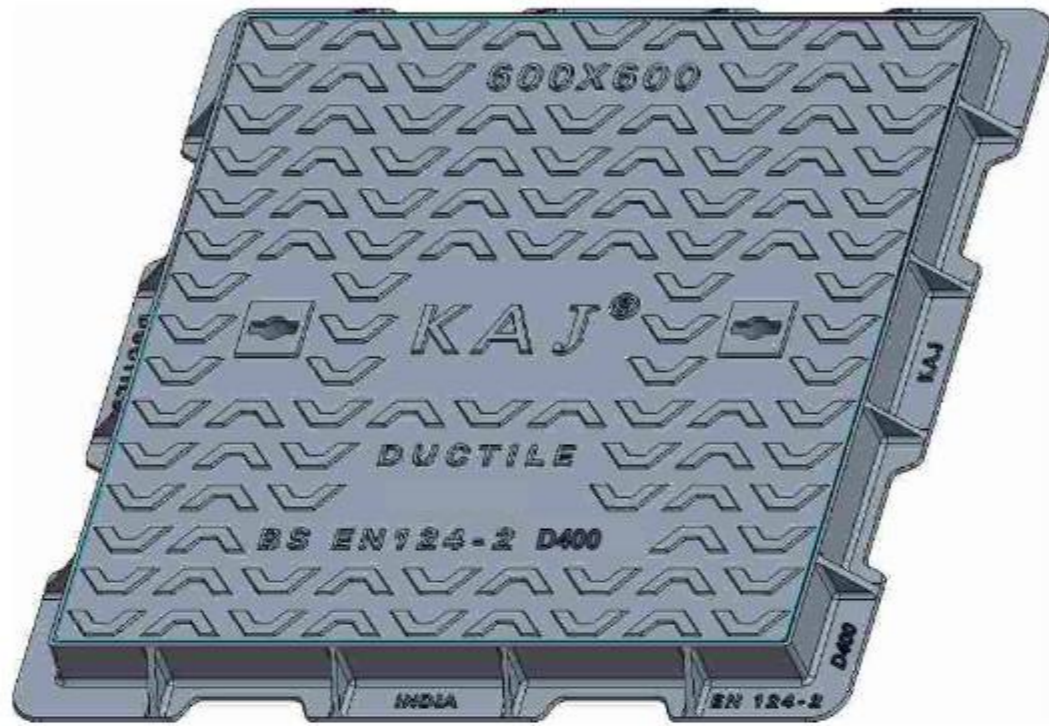

D400 Manhole Covers manufactured to BS-EN 124-2 Compliant skid resistant for high risk location



Anti-flex covers prevent the causes of cover seating wear, eliminating excessive noise and catastrophic failure.



Specially designed cover support geometry reduces movement relative to the frame, minimising seating wear.



Enlarged frame corners help to dissipate, load minimising bearing pressure.



Indexed corners ensure correct orientation first time, every time.



Inspection window allows safe and easy view into chamber.

600X600X50 D 400 SOLID TOP COVER AND FRAME						
S#	CLEAR OPENING	OVER BASE	TOTAL HEIGHT	LOAD CLASS	FEATURES	KITE MARK
	AxA (MM)	BxB (MM)	H (MM)			
1	600 X 600	780 x 780	50	D- 400	Double Seal/ GRP PROVISION	NO

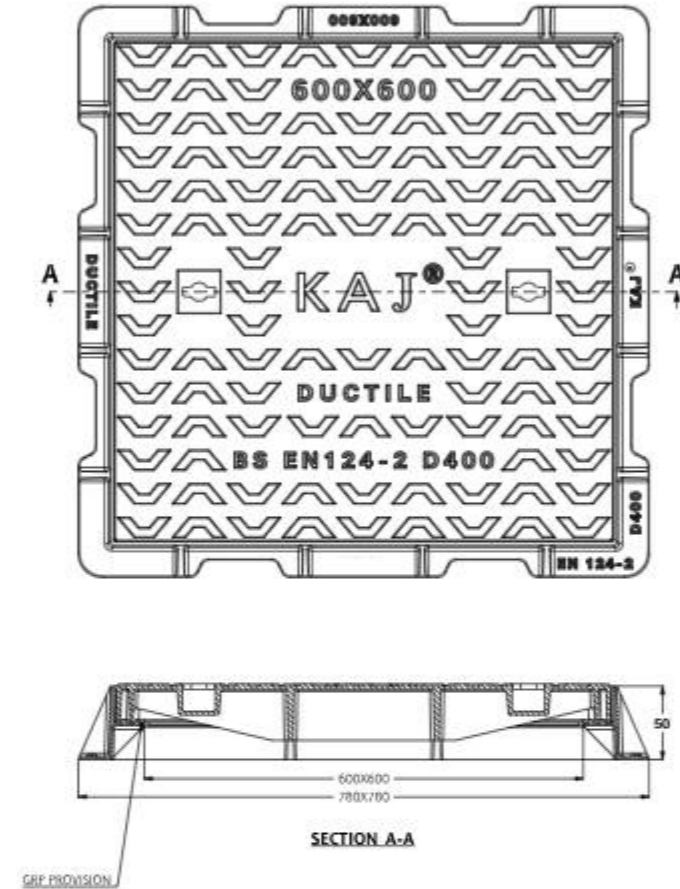

FEATURES:

1. Manufactured as per BS EN 124 -2 Design Standard
2. Can also be designed with a concealed locking mechanism for safer access
3. Load achieve before concrete filling
4. Designed to non-rock
5. Can be provisioned for Gasket and GRP seating
6. Custom Marking/ Logos available on request

REV. NO	DATE	MODIFICATION	NAME	DATE	SIGN.	KAJ® KAJ BUILDING & CONSTRUCTION MATERIALS WHOLESALE TRADING LLC. <small>Registered Office: Plot Number: 525-5 Building Name: ABAJ CENTER, Mal Street - Dubai Email : info@kajworld.com / Website : www.kajworld.com Warehouse : INDUSTRIAL AREA 17 - Malha Street Plot Number: 101, Government Land No. : 102, SAIBAN (UAE)</small>
			DRWN. BY:-	T.R.B	20.02.23	
			CHKD. BY:-	R.Mukherjee	20.02.23	
			APPRD. BY:-	T.R.B	20.02.23	
			MATERIAL:-	DUCTILE IRON EN1563-500/7		
			TOLERANCE:-	ISO 8062 (CT-11)		
			BRAND:-	KAJ		
				LOAD:-	D400	
				SCALE:-	NTS	
			ALL DIMENSIONS ARE IN MM.			

600X600 X50 B 125 SOLID TOP MANHOLE COVER WITH GRP SEALING PROVISION

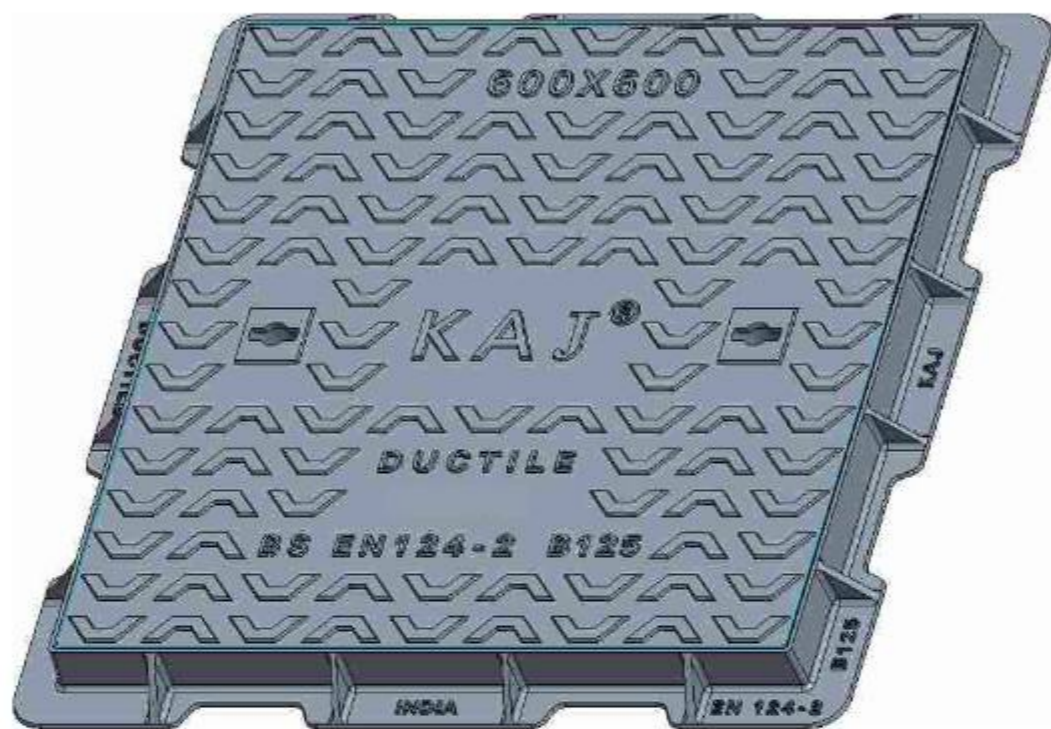

B125 Manhole Covers manufactured to BS-EN 124-2 Compliant skid resistant for high risk location



Anti-flex covers prevent the causes of cover seating wear, eliminating excessive noise and catastrophic failure.



Specially designed cover support geometry reduces movement relative to the frame, minimising seating wear.



Enlarged frame corners help to dissipate, load minimising bearing pressure.



Indexed corners ensure correct orientation first time, every time.



Inspection window allows safe and easy view into chamber.

600X600X50 B 125 SOLID TOP COVER AND FRAME

S#	CLEAR OPENING AxA (MM)	OVER BASE BxB (MM)	TOTAL HEIGHT H (MM)	LOAD CLASS	FEATURES	KITE MARK
1	600 X 600	780 x 780	50	B- 125	Double Seal/ GRP PROVISION	NO

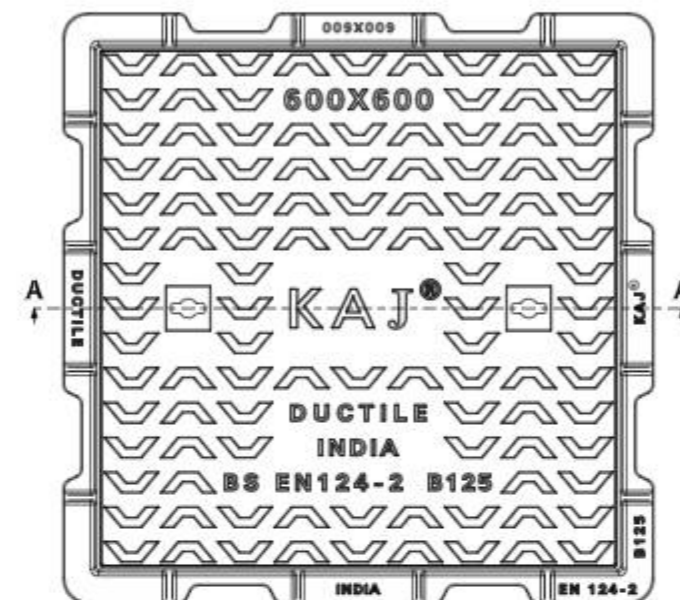

SECTION A-A

FEATURES:

1. Manufactured as per BS EN 124 -2 Design Standard
2. Can also be designed with a concealed locking mechanism for safer access
3. Load achieve before concrete filling
4. Designed to non-rock
5. Can be provisioned for Gasket and GRP seating
6. Custom Marking/ Logos available on request

REV. NO	DATE	MODIFICATION	NAME	DATE	SIGN.
			DRWN. BY:- T.R.B	20.02.23	
			CHKD. BY:- R.Mukharjee	20.02.23	
			APPRD. BY:- T.R.B	20.02.23	
MATERIAL:- DUCTILE IRON EN1563-500/7			TOLERANCE:- ISO 8062 (CT-11)		
BRAND:- KAJ			LOAD:- B 125		
			SCALE:- NTS		
			COAT:- BLACK BITUMEN		
			SHEET NO:- 1 OF 1		
			DRG. NO. K-603 A		

KAJ® KAJ BUILDING & CONSTRUCTION MATERIALS WHOLESALE TRADING LLC.
Registered Office: Plot Number: 125-0 Building Name: ABRA CENTRE, Real Street - Dubai
Email: info@kajworld.com | Website: www.kajworld.com
Workshop: INDUSTRIAL AREA 17 - Mulla Street
Plot Number: 101, Government Land No. - 185, SHARAJH (UAE)

DRAWING DESCRIPTION:-
**600X600 SOLID TOP B 125
FRAME AND COVER (WITH GRP)**

600X600 X80 D 400 RECESS TOP MANHOLE COVER WITH GRP SEALING PROVISION



D400 Manhole Covers manufactured to BS-EN 124-2 Compliant skid resistant for high risk location



Anti-flex covers prevent the causes of cover seating wear, eliminating excessive noise and catastrophic failure.



Specially designed cover support geometry reduces movement relative to the frame, minimising seating wear.



Enlarged frame corners help to dissipate, load minimising bearing pressure.



Indexed corners ensure correct orientation first time, every time.



Inspection window allows safe and easy view into chamber.

600 X 600 X 80 RECESS TOP COVER & FRAME D 400							
S#	CLEAR OPENING AxA (MM)	OVER BASE BxB (MM)	TOTAL DEPTH H (MM)	RECESSED DEPTH R (MM)	LOAD CLASS	FEATURES	KITE MARK
1	600 X 600	785 x 785	100	80	D - 400	Double Seal/ GRP PROVISION	NO

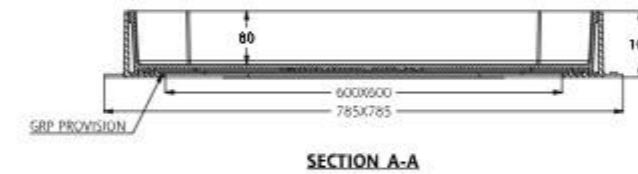
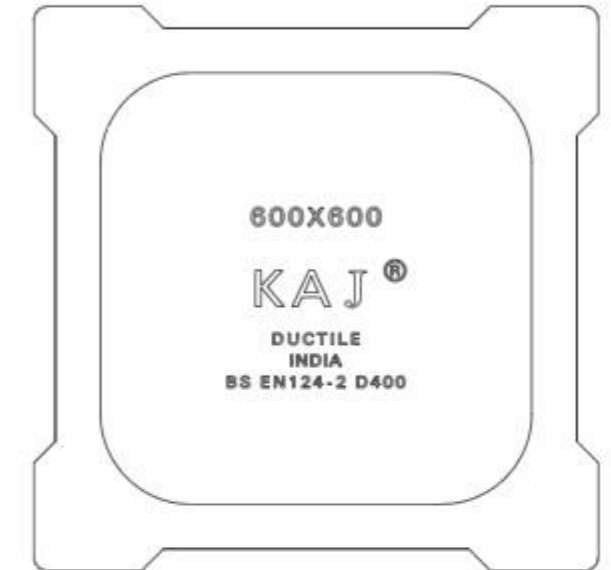
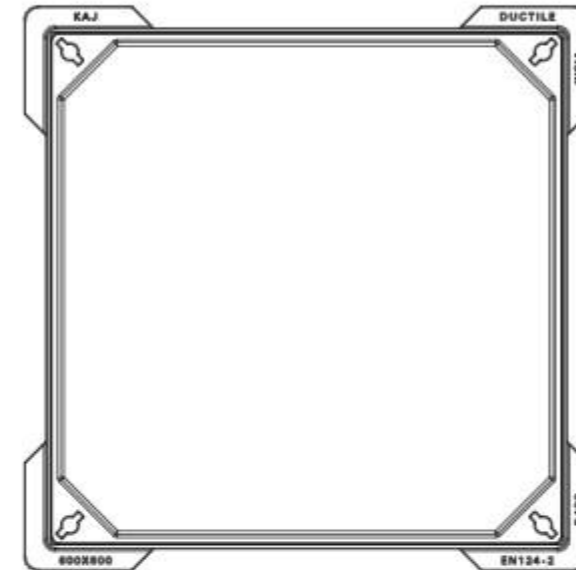

FEATURES:

1. Manufactured as per BS EN 124 -2 Design Standard
2. Can also be designed with a concealed locking mechanism for safer access
3. Load achieve before concrete filling
4. Designed to non-rock
5. Can be provisioned for Gasket and GRP seating
6. Custom Marking/ Logos available on request

REV. NO	DATE	MODIFICATION	NAME	DATE	SIGN.	KAJ® KAJ BUILDINGS & CONSTRUCTION MATERIALS WHOLESALE TRADING LLC. Registered Office: Plot Number - 127 D Building Name - KBAK CHITRE, Red Street - Dabai Email : info@kajworld.com / Website : www.kajworld.com Warehouse : INDUSTRIAL AREA-17 Madha Street Plot Number : 101, Government Land No : 301, SIKHRAJ (L&T)
			DRWN. BY:-	T.R.B	20.02.23	
			CHKD. BY:-	R.Mukherjee	20.02.23	
			APPRD. BY:-	T.R.B	20.02.23	
			MATERIAL:-	DUCTILE IRON EN1563-500/7		
			TOLERANCE:-	ISO 8062 (CT-11)		
			BRAND:-	KAJ		
				LOAD:-	D400	
				SCALE:-	NTS	
			ALL DIMENSIONS ARE IN MM.			

600X600 X80 B125 RECESS TOP MANHOLE COVER WITH GRP SEALING PROVISION

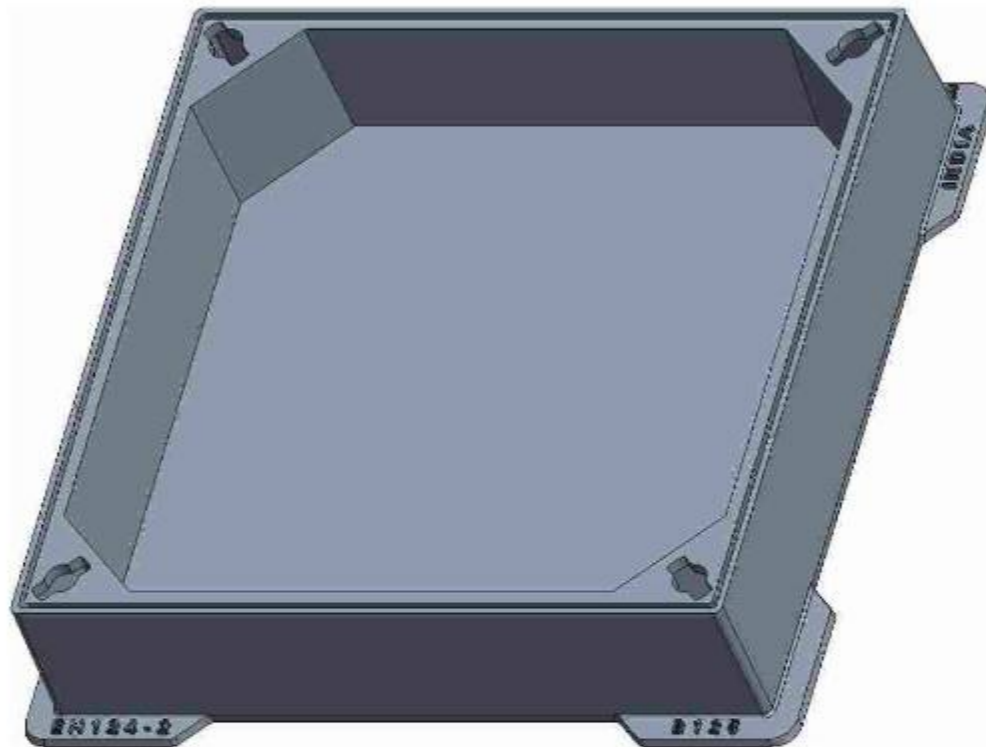

B125 Manhole Covers manufactured to BS-EN 124-2 Compliant skid resistant for high risk location



Anti-flex covers prevent the causes of cover seating wear, eliminating excessive noise and catastrophic failure.



Specially designed cover support geometry reduces movement relative to the frame, minimising seating wear.



Enlarged frame corners help to dissipate, load minimising bearing pressure.



Indexed corners ensure correct orientation first time, every time.



Inspection window allows safe and easy view into chamber.

600 X 600 X 80 RECESS TOP COVER & FRAME B 125							
S#	CLEAR OPENING AxA (MM)	OVER BASE BxB (MM)	TOTAL DEPTH H (MM)	RECESSED DEPTH R (MM)	LOAD CLASS	FEATURES	KITE MARK
1	600 X 600	785 x 785	100	80	B - 125	Double Seal/ GRP PROVISION	NO

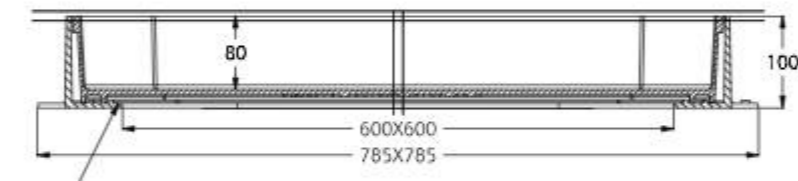
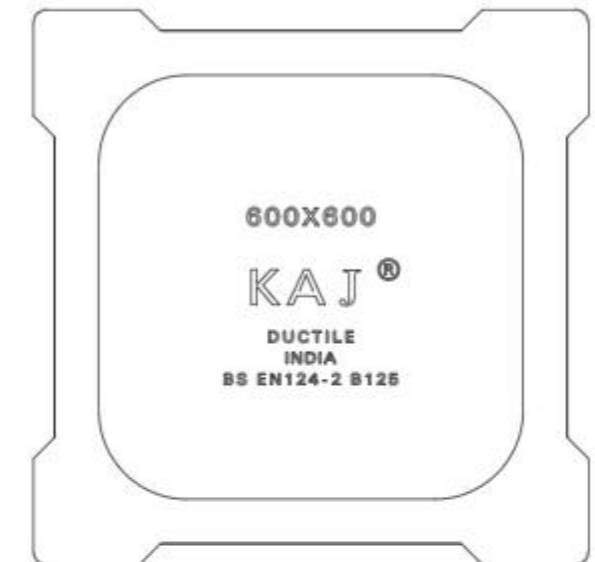
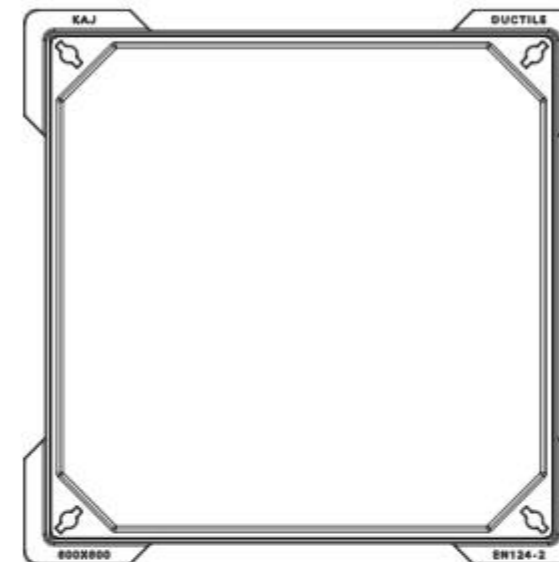

SECTION A-A

FEATURES:

1. Manufactured as per BS EN 124 -2 Design Standard
2. Can also be designed with a concealed locking mechanism for safer access
3. Load achieve before concrete filling
4. Designed to non-rock
5. Can be provisioned for Gasket and GRP seating
6. Custom Marking/ Logos available on request

REV. NO	DATE	MODIFICATION	NAME	DATE	SIGN.	KAJ® KAJ BUILDING & CONSTRUCTION MATERIALS WHOLESALE TRADING LLC. Registered Office: Plot Number: 125-0 Building Name: ABRA CENTRE, Red Street - Dabra Email: info@kajworld.com / Website: www.kajworld.com Warehouse: INDUSTRIAL AREA 17-Mulla Street Plot Number: 101, Government Land No. - 101, SIMBANI (JAK)
			DRWN. BY:-	T.R.B	20.02.23	
			CHKD. BY:-	R.Mukherjee	20.02.23	
			APPRD. BY:-	T.R.B	20.02.23	
			MATERIAL:-	DUCTILE IRON EN1563-500/7		
			TOLERANCE:-	ISO 8062 (CT-11)		
			BRAND:-	KAJ		
				LOAD:-	B 125	
				SCALE:-	NTS	
				ALL DIMENSIONS ARE IN MM.		

600X600X80 D400 GRATE MANHOLE COVER



D400 Manhole Covers manufactured to BS-EN 124-2 Compliant skid resistant for high risk location



Anti-flex covers prevent the causes of cover seating wear, eliminating excessive noise and catastrophic failure.



Specially designed cover support geometry reduces movement relative to the frame, minimising seating wear.



Enlarged frame corners help to dissipate, load minimising bearing pressure.



Indexed corners ensure correct orientation first time, every time.



Inspection window allows safe and easy view into chamber.

600X600 X80 D400 GULLY GRATE						
S#	CLEAR OPENING AxA (MM)	OVER BASE BxB (MM)	TOTAL HEIGHT H (MM)	LOAD CLASS	FEATURES	KITE MARK
1	600 X 600	700 x 700	80	D - 400	Single Seal	NO

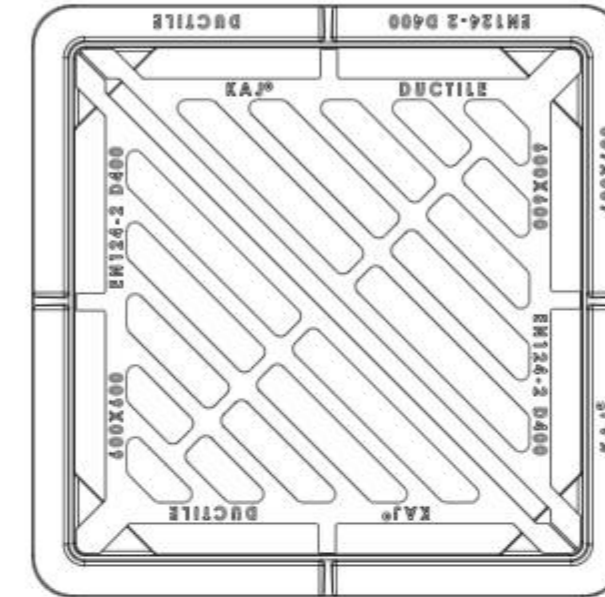

TOP VIEW

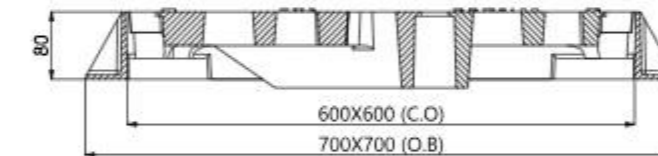

SECTION VIEW

FEATURES:

1. Manufactured as per BS EN 124 -2 Design Standard
2. Can also be designed with a concealed locking mechanism for safer access
3. Load achieve before concrete filling
4. Designed to non-rock
5. Can be provisioned for Gasket and GRP seating
6. Custom Marking/ Logos available on request

DRWN. BY:-	T.R.B	20.02.23	SIGN.	KAJ® KAJ BUILDING & CONSTRUCTION MATERIALS WHOLESALE TRADING LLC. Regional Office: Plot Number: 123-D Building Name: ABRA CENTRE, Red Street - Doha Email: info@kajworld.com / Website: www.kajworld.com Warehouse: INDUSTRIAL AREA 17 - Mulla Street Plot Number: 191, Government Land No.: 102, SHARBAH (QAR)
CHKD. BY:-	R.Mukherjee	20.02.23		
APPRD. BY:-	T.R.B	20.02.23		
MATERIAL:- DUCTILE IRON EN1563-500/7				
TOLERANCE:- ISO 8062 (CT-11)				DRAWING DESCRIPTION:- 600X600 D 400 GULLY GRATE S/S
BRAND:- KAJ				
LOAD:- D400 SCALE:- NTS				
REV. NO	DATE	MODIFICATION	ALL DIMENSIONS ARE IN MM.	COAT:- BLACK BITUMEN SHEET NO:- 1 OF 1 DRG. NO. K-606 A

600X600X100 D400 SOLID TOP DOUBLE TRIANGLE WITH GRP PROVISION



B125 Manhole Covers manufactured to BS-EN 124-2 Compliant skid resistant for high risk location



Anti-flex covers prevent the causes of cover seating wear, eliminating excessive noise and catastrophic failure.



Specially designed cover support geometry reduces movement relative to the frame, minimising seating wear.



Enlarged frame corners help to dissipate, load minimising bearing pressure.



Indexed corners ensure correct orientation first time, every time.



Inspection window allows safe and easy view into chamber.

600X600X100 D400 SOLID TOP DOUBLE TRIANGLE						
S#	CLEAR OPENING AxA (MM)	OVER BASE BxB (MM)	TOTAL HEIGHT H (MM)	LOAD CLASS	FEATURES	KITE MARK
1	600 X 600	700 x 700	100	D - 400	Double Seal/ GRP PROVISION	NO

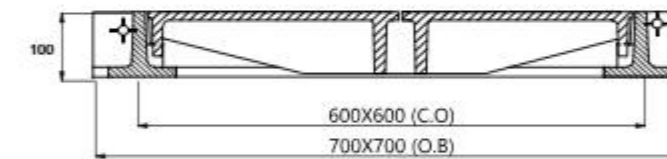
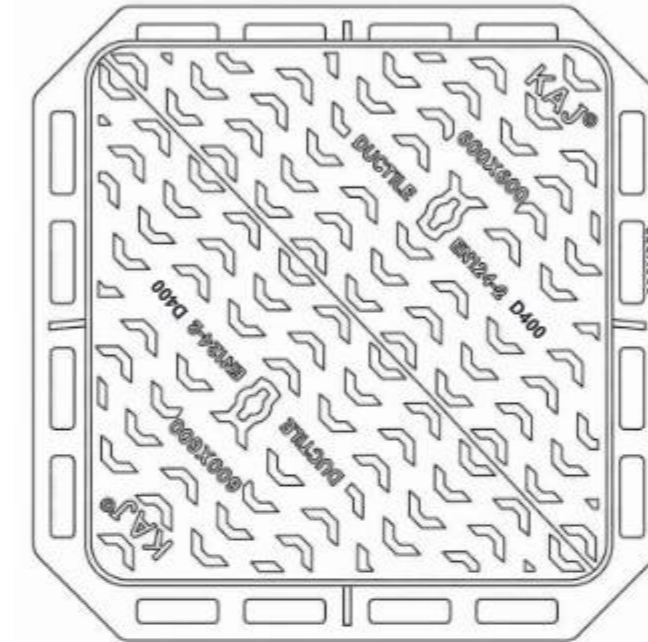

SECTION VIEW

FEATURES:

1. Manufactured as per BS EN 124 -2 Design Standard
2. Can also be designed with a concealed locking mechanism for safer access
3. Load achieve before concrete filling
4. Designed to non-rock
5. Can be provisioned for Gasket and GRP seating
6. Custom Marking/ Logos available on request

REV. NO	DATE	MODIFICATION	NAME	DATE	SIGN.	KAJ® KAJ BUILDING & CONSTRUCTION MATERIALS WHOLESALE TRADING LLC. Registered Office: Plot Number: 125-0 Building Name: ABRA CENTRE, Red Street - Dubai Email: info@kajworld.com / Website: www.kajworld.com Warehouse: INDUSTRIAL AREA 17- Mulla Street Plot Number: 101, Government Land No. - 145, SHARAJH (UAE)
			DRWN. BY:- T.R.B	20.02.23		
			CHKD. BY:- R.Mukherjee	20.02.23		COAT:- BLACK BITUMEN SHEET NO:- 1 OF 1 DRG. NO. K-607 A
			APPRD. BY:- T.R.B	20.02.23		
						LOAD:- D400 SCALE:- NTS
			ALL DIMENSIONS ARE IN MM.			

600 X 600 D400 GULLY GRATE SINGLE SEAL COVER AND FRAME

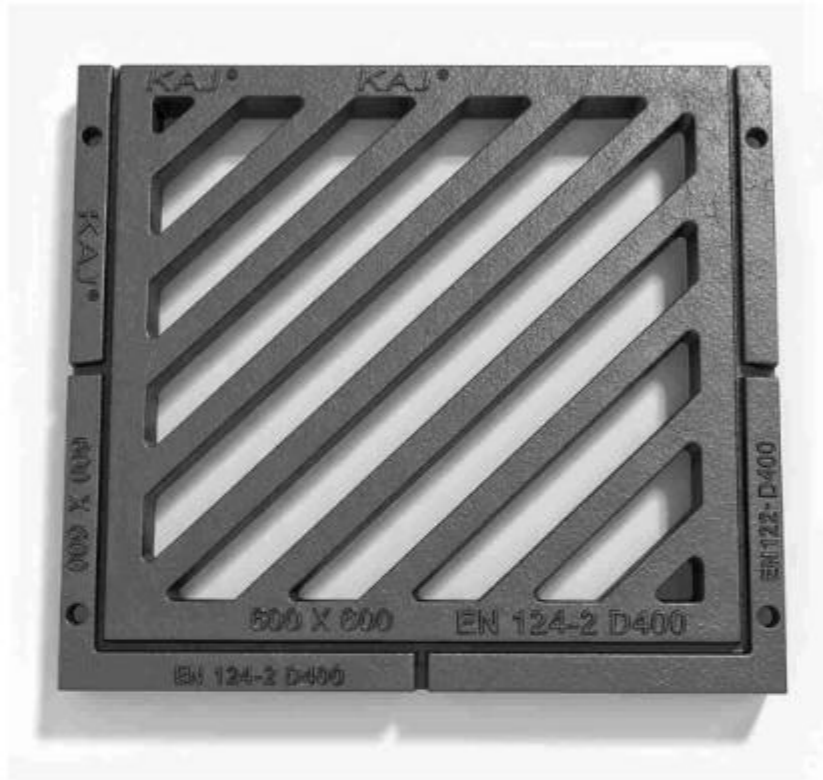

D400 Chanel Grating manufactured to BS-EN 124-2 Compliant skid resistant for high risk location



Anti-flex covers prevent the causes of cover seating wear, eliminating excessive noise and catastrophic failure.



Specially designed cover support geometry reduces movement relative to the frame, minimising seating wear.



Enlarged frame corners help to dissipate, load minimising bearing pressure.



Indexed corners ensure correct orientation first time, every time.



Inspection window allows safe and easy view into chamber.

600 X 600 D400 GULLY GRATE SINGLE SEAL COVER AND FRAME

S#	CLEAR OPENING AxA (MM)	OVER BASE BxB (MM)	TOTAL HEIGHT H (MM)	LOAD CLASS	FEATURES	KITE MARK
1	600 X 600	780 X 780	80	D- 400	Single Seal	NO

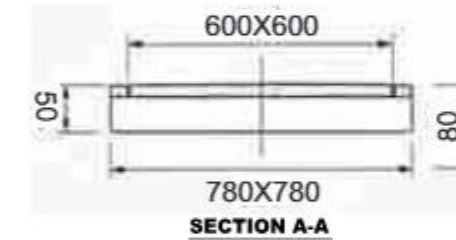
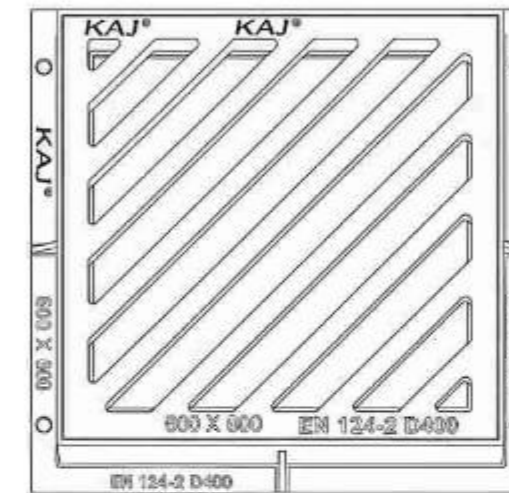

FEATURES:

1. Manufactured as per BS EN 124 -2 Design Standard
2. Can also be designed with a concealed locking mechanism for safer access
3. Load achieve before concrete filling
4. Designed to non-rock
5. Can be provisioned for Gasket and GRP seating
6. Custom Marking/ Logos available on request

REV. NO	DATE	MODIFICATION	NAME	DATE	SIGN.	KAJ® KAJ BUILDING MATERIAL PVT. LTD. <small>Regional Office: Plot Number: A/10 Building Name: KAJ, L/10/1, 1st Floor - Suba Email: info@kajworld.com Website: www.kajworld.com Warehouse: INDUSTRIAL AREA 17, Madhav Street Plot Number: 104, Government Layout - 16, Saranagar (KAJ)</small>
			DRWN. BY:-	T.R.B	20.02.23	
			CHKD. BY:-	R.Mukherjee	20.02.23	
			APPRD. BY:-	T.R.B	20.02.23	
			MATERIAL:-	DUCTILE IRON EN1563-500/7		
			TOLERANCE:-	ISO 8062 (CT-11)		
			BRAND:-	KAJ		
				LOAD:-	D400	
				SCALE:-	NTS	
			ALL DIMENSIONS ARE IN MM.			

600 X 600 D400 SQUARE DISHED PATTERN GULLY GRIDS



D400 Chanel Grating manufactured to BS-EN 124-2 Compliant skid resistant for high risk location



Anti-flex covers prevent the causes of cover seating wear, eliminating excessive noise and catastrophic failure.



Specially designed cover support geometry reduces movement relative to the frame, minimising seating wear.



Enlarged frame corners help to dissipate, load minimising bearing pressure.



Indexed corners ensure correct orientation first time, every time.



Inspection window allows safe and easy view into chamber.

600 X 600 D400 SQUARE DISHED PATTERN GULLY GRIDS

S#	CLEAR OPENING AxA (MM)	OVER BASE BxB (MM)	TOTAL HEIGHT H (MM)	LOAD CLASS	FEATURES	KITE MARK
1	600 X 600	780 X 780	80	D-400	Double Seal	NO

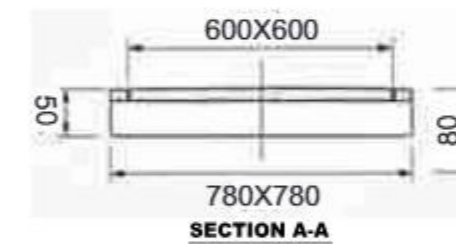
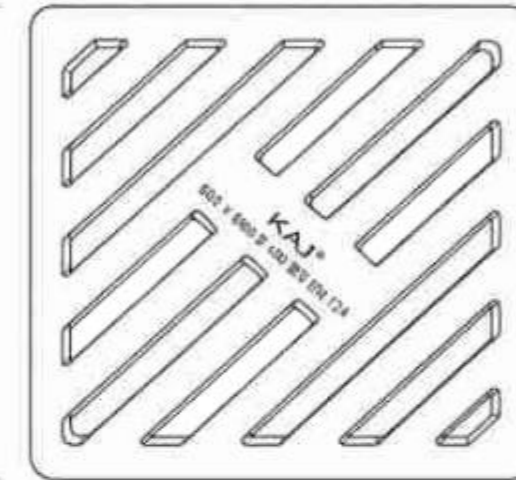

FEATURES:

1. Manufactured as per BS EN 124 -2 Design Standard
2. Can also be designed with a concealed locking mechanism for safer access
3. Load achieve before concrete filling
4. Designed to non-rock
5. Can be provisioned for Gasket and GRP seating
6. Custom Marking/ Logos available on request

REV. NO	DATE	MODIFICATION	NAME	DATE	SIGN.	KAJ® KAJ BUILDING MATERIAL PVT. LTD. <small>Regional Office: Plot Number: A/10 Building Name: KAJ, L/10/1, 1st Floor - Suba Email: info@kajworld.com Website: www.kajworld.com Warehouse: INDUSTRIAL AREA 17, Madhav Street Plot Number: 104, Government Layout - 16, 500001 (KJ)</small>
			DRWN. BY:-	T.R.B	20.02.23	
			CHKD. BY:-	R.Mukherjee	20.02.23	
			APPRD. BY:-	T.R.B	20.02.23	
			MATERIAL:-	DUCTILE IRON EN1563-500/7		
			TOLERANCE:-	ISO 8062 (CT-11)		
			BRAND:-	KAJ		
				LOAD:-	D400	
				SCALE:-	NTS	
			ALL DIMENSIONS ARE IN MM.			

800X800X100 D400 SOLID TOP MANHOLE COVER WITH GRP SEALING PROVISION

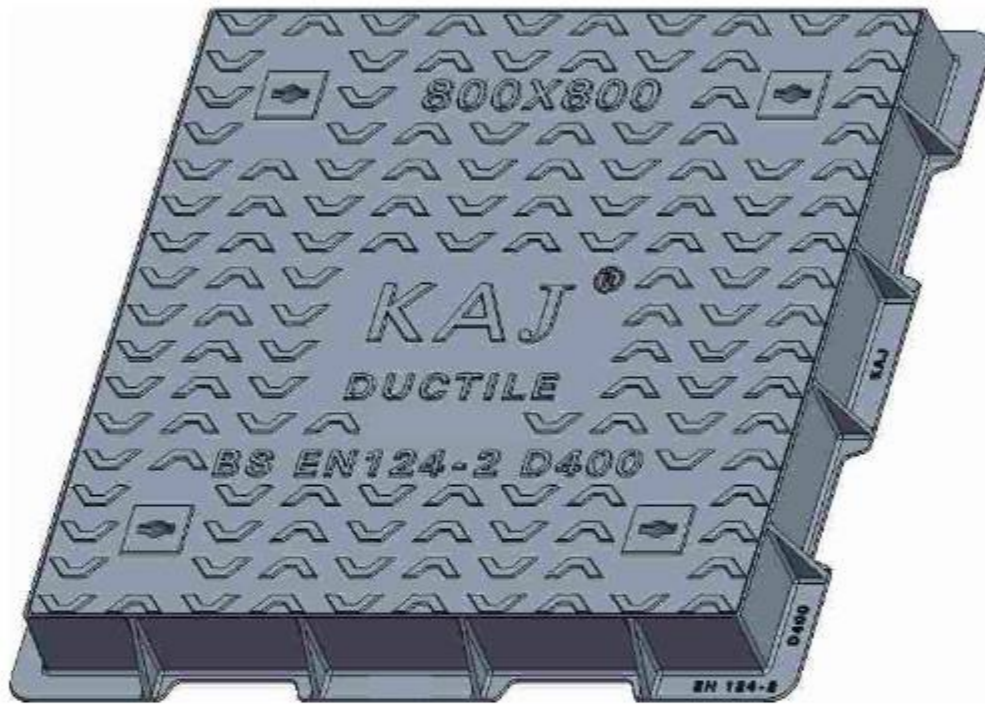

D400 Manhole Covers manufactured to BS-EN 124-2 Compliant skid resistant for high risk location



Anti-flex covers prevent the causes of cover seating wear, eliminating excessive noise and catastrophic failure.



Specially designed cover support geometry reduces movement relative to the frame, minimising seating wear.



Enlarged frame corners help to dissipate, load minimising bearing pressure.



Indexed corners ensure correct orientation first time, every time.



Inspection window allows safe and easy view into chamber.

800X800X100 D 400 SOLID TOP COVER AND FRAME						
S#	CLEAR OPENING	OVER BASE	TOTAL HEIGHT	LOAD CLASS	FEATURES	KITE MARK
	AxA (MM)	BxB (MM)	H (MM)			
1	800 X 800	980 x 980	100	D- 400	Double Seal/ GRP PROVISION	NO

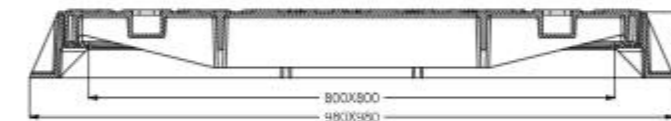
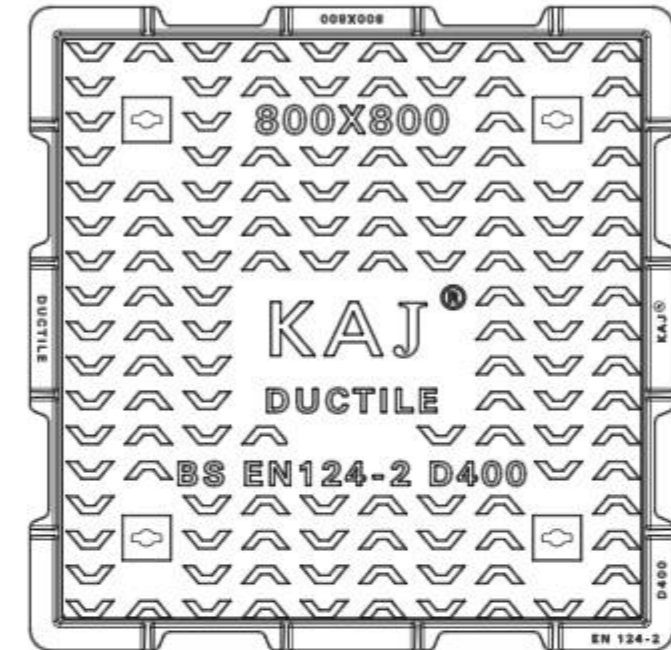

FEATURES:

1. Manufactured as per BS EN 124 -2 Design Standard
2. Can also be designed with a concealed locking mechanism for safer access
3. Load achieve before concrete filling
4. Designed to non-rock
5. Can be provisioned for Gasket and GRP seating
6. Custom Marking/ Logos available on request

REV. NO	DATE	MODIFICATION	NAME	DATE	SIGN.
			DRWN. BY:-	T.R.B	20.02.23
			CHKD. BY:-	R.Mukherjee	20.02.23
			APPRD. BY:-	T.R.B	20.02.23
			MATERIAL:- DUCTILE IRON EN1563-500/7		
			TOLERANCE:- ISO 8062 (CT-11)		
			BRAND:- KAJ		
			LOAD:-	D400	
			SCALE:-	NTS	
			ALL DIMENSIONS ARE IN MM.		

KAJ® KAJ BUILDING & CONSTRUCTION MATERIALS WHOLESALE TRADING LLC.
 Registered Office: Plot Number - 107-0 Building Name - KAJA CENTRA, Red Street - Dubai
 E-mail: info@kajworld.com | Website: www.kajworld.com
 Warehouse: NEZWAH AREA-17- Madha Street
 Plot Number: 101, Government Land No. - 101, SHARJAH (UAE)

DRAWING DESCRIPTION:-

**800X800 SOLID TOP D400
 FRAME AND COVER (WITH GRP)**

COAT:- BLACK BITUMEN

SHEET NO:- 1 OF 1

DRG. NO. **K-801 A**

800X800X80 B 125 SOLID TOP MANHOLE COVER WITH GRP SEALING PROVISION

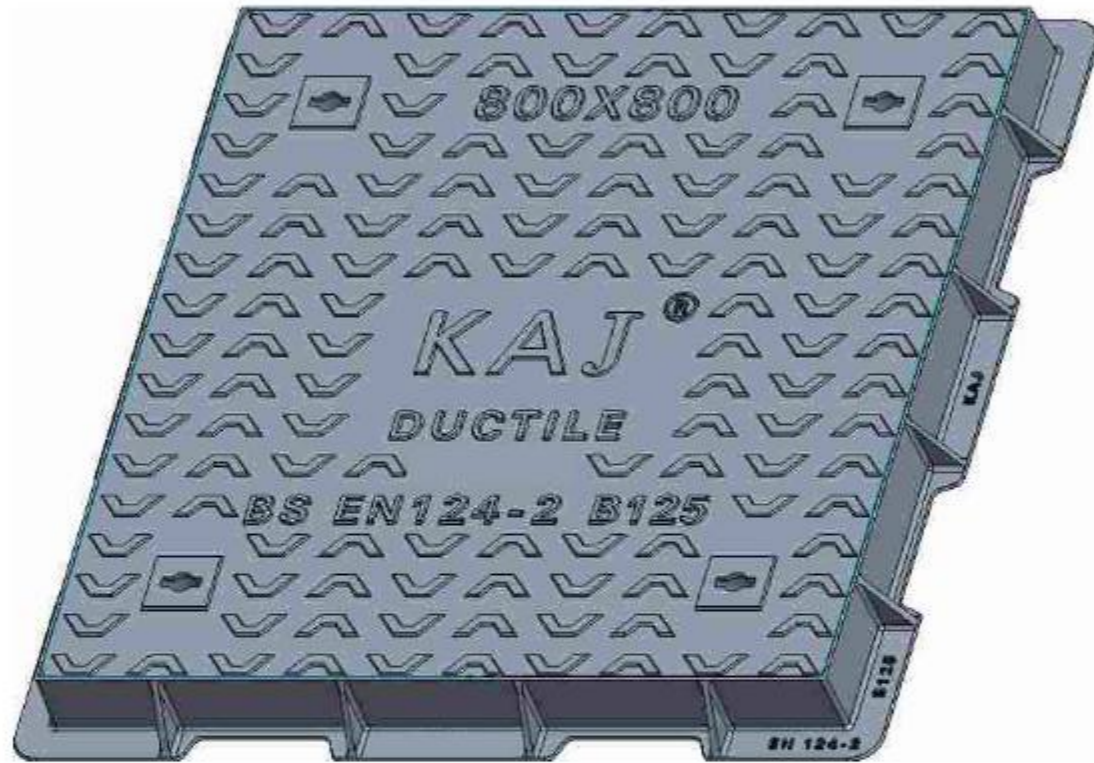

B125 Manhole Covers manufactured to BS-EN 124-2 Compliant skid resistant for high risk location



Anti-flex covers prevent the causes of cover seating wear, eliminating excessive noise and catastrophic failure.



Specially designed cover support geometry reduces movement relative to the frame, minimising seating wear.



Enlarged frame corners help to dissipate, load minimising bearing pressure.



Indexed corners ensure correct orientation first time, every time.



Inspection window allows safe and easy view into chamber.

800X800 X80 B 125 SOLID TOP COVER AND FRAME						
S#	CLEAR OPENING	OVER BASE	TOTAL HEIGHT	LOAD CLASS	FEATURES	KITE MARK
	AxA (MM)	BxB (MM)	H (MM)			
1	800 X 800	980 x980	80	B- 125	Double Seal/ GRP PROVISION	NO

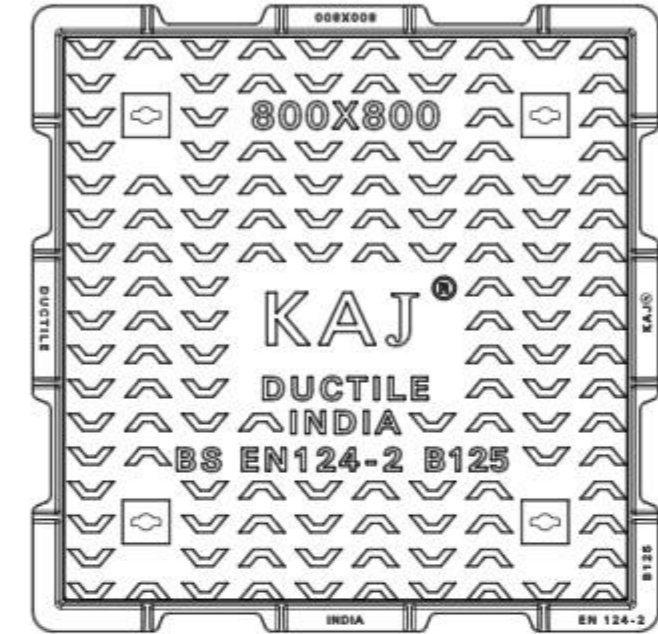

SECTION A-A

FEATURES:

1. Manufactured as per BS EN 124 -2 Design Standard
2. Can also be designed with a concealed locking mechanism for safer access
3. Load achieve before concrete filling
4. Designed to non-rock
5. Can be provisioned for Gasket and GRP seating
6. Custom Marking/ Logos available on request

REV. NO	DATE	MODIFICATION	NAME	DATE	SIGN.	KAJ[®] KAJ BUILDING & CONSTRUCTION MATERIALS WHOLESALE TRADING LLC. Registered Office: Plot Number: 553-D Building Name: ABRA CIRCLE, Mal' Street - Sakar Email: info@kajworld.com / Website: www.kajworld.com Warehouse: INDUSTRIAL AREA-13-Medha Street Plot Number: 701, Government Land No. - 101, SARANI (GAJ)	DRAWING DESCRIPTION:- 800X800 SOLID TOP B 125 FRAME AND COVER (WITH GRP)	COAT:- BLACK BITUMEN SHEET NO:- 1 OF 1 DRG. NO. K-602 A
			DRWN. BY:-	T.R.B	20.02.23			
			CHKD. BY:-	R.Mukharjee	20.02.23			
			APPRD. BY:-	T.R.B	20.02.23			
			MATERIAL:- DUCTILE IRON EN1563-500/7					
			TOLERANCE:- ISO 8062 (CT-11)					
			BRAND:- KAJ					
			LOAD:- B 125					
			SCALE:- NTS					
			ALL DIMENSIONS ARE IN MM.					

800X800 X80 D400 RECESS TOP MANHOLE COVER WITH GRP SEALING PROVISION



D400 Manhole Covers manufactured to BS-EN 124-2 Compliant skid resistant for high risk location



Anti-flex covers prevent the causes of cover seating wear, eliminating excessive noise and catastrophic failure.



Specially designed cover support geometry reduces movement relative to the frame, minimising seating wear.



Enlarged frame corners help to dissipate, load minimising bearing pressure.



Indexed corners ensure correct orientation first time, every time.



Inspection window allows safe and easy view into chamber.

800 X 800 X 80 RECESS TOP COVER & FRAME D 400

S#	CLEAR OPENING	OVER BASE	TOTAL DEPTH	RECESSED DEPTH	LOAD CLASS	FEATURES	KITE MARK
	AxA (MM)	BxB (MM)	H (MM)	R (MM)			
1	800 X 800	985 x 985	100	80	D - 400	Double Seal/ GRP PROVISION	NO

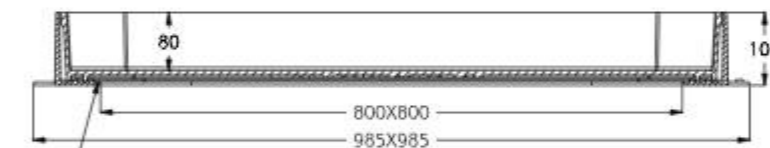
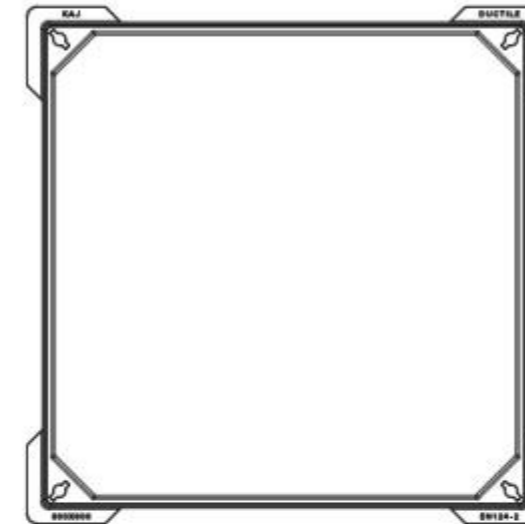

GRP PROVISION SECTION A-A

FEATURES:

1. Manufactured as per BS EN 124 -2 Design Standard
2. Can also be designed with a concealed locking mechanism for safer access
3. Load achieve before concrete filling
4. Designed to non-rock
5. Can be provisioned for Gasket and GRP seating
6. Custom Marking/ Logos available on request

REV. NO	DATE	MODIFICATION	NAME	DATE	SIGN.	KAJ® KAJ BUILDING & CONSTRUCTION MATERIALS WHOLESALE TRADING LLC. Regional Office: Plot Number - 129-B Building Name - JBSU CENTER, Kurla Street - Dabur E-mail: info@kajworld.com Website: www.kajworld.com Warehouse: WESTRAL AREA-27- Malibu Street Plot Number: 193, Government Land No. - 102, SHARDA (BKC)
			DRWN. BY:-	T.R.B	20.02.23	
			CHKD. BY:-	R.Mukherjee	20.02.23	
			APPRD. BY:-	T.R.B	20.02.23	
			MATERIAL:-	DUCTILE IRON EN1563-500/7		
			TOLERANCE:-	ISO 8062 (CT-11)		
			BRAND:-	KAJ		
						LOAD:- D400
						SCALE:- NTS
						ALL DIMENSIONS ARE IN MM.

800X800X80 B125 RECESS TOP MANHOLE COVER WITH GRP SEALING PROVISION



B125 Manhole Covers manufactured to BS-EN 124-2 Compliant skid resistant for high risk location



Anti-flex covers prevent the causes of cover seating wear, eliminating excessive noise and catastrophic failure.



Specially designed cover support geometry reduces movement relative to the frame, minimising seating wear.



Enlarged frame corners help to dissipate, load minimising bearing pressure.



Indexed corners ensure correct orientation first time, every time.



Inspection window allows safe and easy view into chamber.

800X800X80 RECESS TOP COVER & FRAME B 125							
S#	CLEAR OPENING AxA (MM)	OVER BASE BxB (MM)	TOTAL DEPTH H (MM)	RECESSED DEPTH R (MM)	LOAD CLASS	FEATURES	KITE MARK
1	800 X 800	985 x 985	100	80	B - 125	Double Seal/ GRP PROVISION	NO

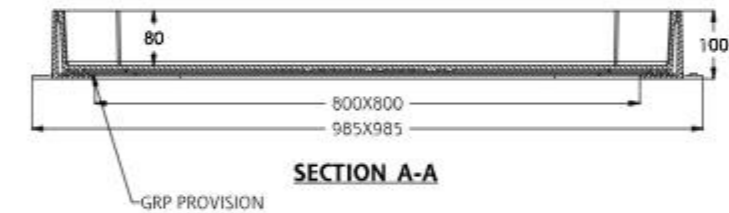
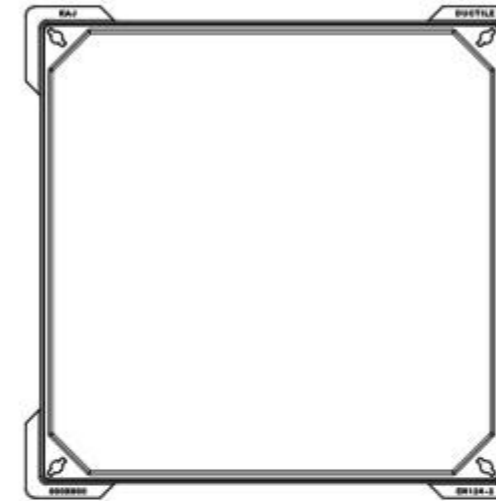

FEATURES:

1. Manufactured as per BS EN 124 -2 Design Standard
2. Can also be designed with a concealed locking mechanism for safer access
3. Load achieve before concrete filling
4. Designed to non-rock
5. Can be provisioned for Gasket and GRP seating
6. Custom Marking/ Logos available on request

REV. NO	DATE	MODIFICATION	NAME	DATE	SIGN.	KAJ® KAJ BUILDING & CONSTRUCTION MATERIALS WHOLESALE TRADING LLC. <small>Registered Office: Plot Number - 425/8 Building Name - ARBA CENTER, Main Street - Dabra Email : info@kajworld.com Website : www.kajworld.com Warehouse : REGIONAL AREA - I - Main Street Plot Number : 151, Government Land No. : 102, SHARDA (JAK)</small>
			DRWN. BY:-	T.R.B	20.02.23	
			CHKD. BY:-	R.Mukherjee	20.02.23	
			APPRD. BY:-	T.R.B	20.02.23	
			MATERIAL:-	DUCTILE IRON EN1563-500/7		
			TOLERANCE:-	ISO 8062 (CT-11)		
			BRAND:-	KAJ		
				LOAD:-	B 125	
				SCALE:-	NTS	
			ALL DIMENSIONS ARE IN MM.			

1000X1000X100 D400 SOLID TOP MANHOLE COVER WITH GRP SEALING PROVISION

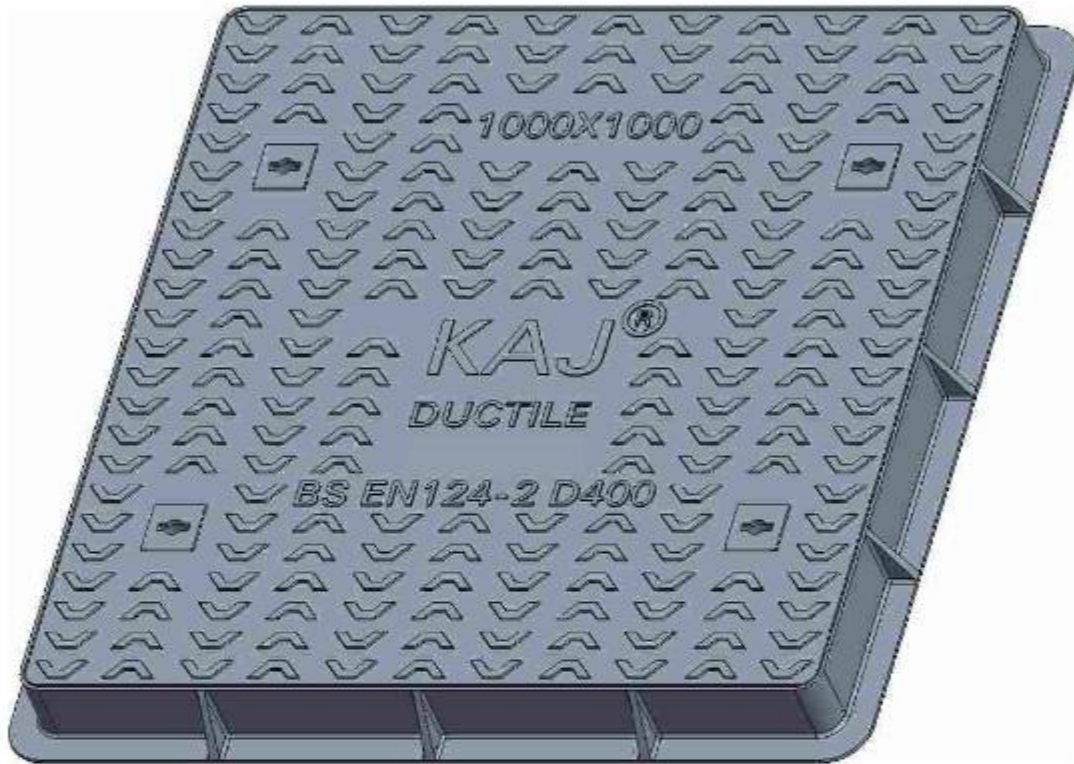

D400 Manhole Covers manufactured to BS-EN 124-2 Compliant skid resistant for high risk location



Anti-flex covers prevent the causes of cover seating wear, eliminating excessive noise and catastrophic failure.



Specially designed cover support geometry reduces movement relative to the frame, minimising seating wear.



Enlarged frame corners help to dissipate, load minimising bearing pressure.



Indexed corners ensure correct orientation first time, every time.



Inspection window allows safe and easy view into chamber.

1000X1000X100 D 400 SOLID TOP COVER AND FRAME						
S#	CLEAR OPENING AxA (MM)	OVER BASE BxB (MM)	TOTAL HEIGHT H (MM)	LOAD CLASS	FEATURES	KITE MARK
1	1000 X 1000	1222 x 1222	100	D- 400	Double Seal/ GRP PROVISION	NO

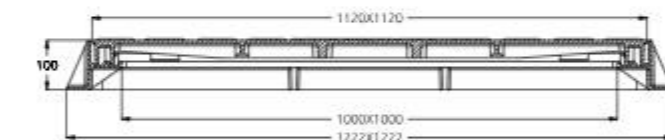
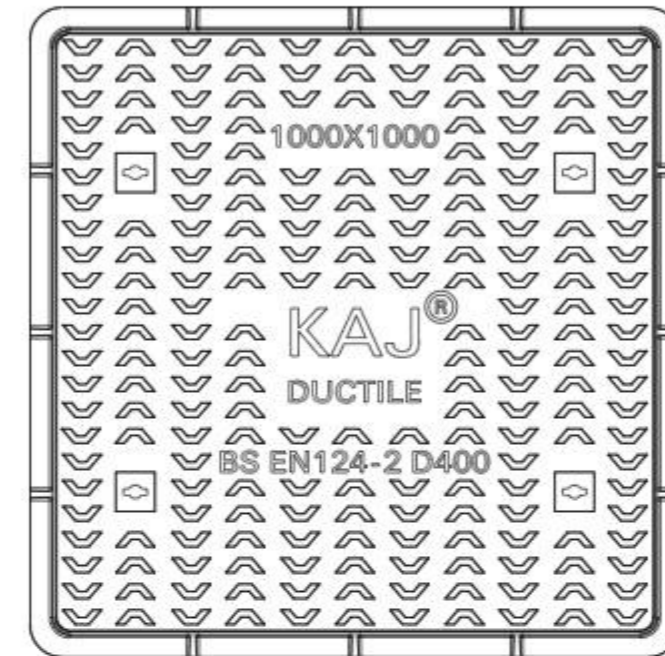

SECTION A-A

FEATURES:

1. Manufactured as per BS EN 124 -2 Design Standard
2. Can also be designed with a concealed locking mechanism for safer access
3. Load achieve before concrete filling
4. Designed to non-rock
5. Can be provisioned for Gasket and GRP seating
6. Custom Marking/ Logos available on request

REV. NO	DATE	MODIFICATION	NAME	DATE	SIGN.
			DRWN. BY:- T.R.B	20.02.23	
			CHKD. BY:- R.Mukherjee	20.02.23	
			APPRD. BY:- T.R.B	20.02.23	
			MATERIAL:- DUCTILE IRON EN1563-500/7		
			TOLERANCE:- ISO 8062 (CT-11)		
			BRAND:- KAJ		
			LOAD:- D400		
			SCALE:- NTS		
			ALL DIMENSIONS ARE IN MM.		

KAJ® KAJ BUILDING & CONSTRUCTION MATERIALS WHOLESALE TRADING LLC.
Registered Office: Plot Number - 629-G Building Name - ABRA CENTER, Real Street - Dubai
E-mail: info@kajworld.com | Website: www.kajworld.com
Warehouse: INDUSTRIAL AREA-17 - Mirdra Street
Plot Number: 101, Government Land No. - 161, SHARJAH (UAE)

DRAWING DESCRIPTION:-
**1000X1000X 100 SOLID TOP D400
FRAME AND COVER (WITH GRP)**

COAT:- BLACK BITUMEN

SHEET NO:- 1 OF 1

DRG. NO. **K-1000A**

200X750 X50 D400 CHANNEL GRATING MANHOLE COVER WITH GRP SEALING PROVISION

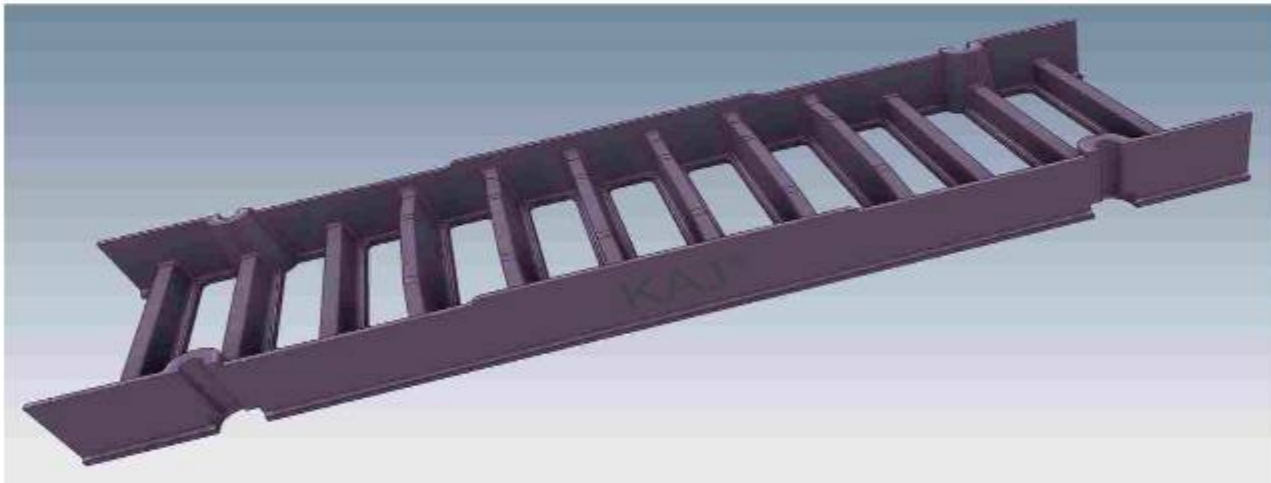

D400 Chanel Grating manufactured to BS-EN 124-2 Compliant skid resistant for high risk location



Anti-flex covers prevent the causes of cover seating wear, eliminating excessive noise and catastrophic failure.



Specially designed cover support geometry reduces movement relative to the frame, minimising seating wear.



Enlarged frame corners help to dissipate, load minimising bearing pressure.



Indexed corners ensure correct orientation first time, every time.



Inspection window allows safe and easy view into chamber.

200X750 X50 D400 CHANNEL GRATING

S#	CLEAR OPENING AxA (MM)	OVER BASE BxB (MM)	TOTAL HEIGHT H (MM)	LOAD CLASS	FEATURES	KITE MARK
1	200 X 750	750x 335	50	D- 400	BOLD PROVISION	NO

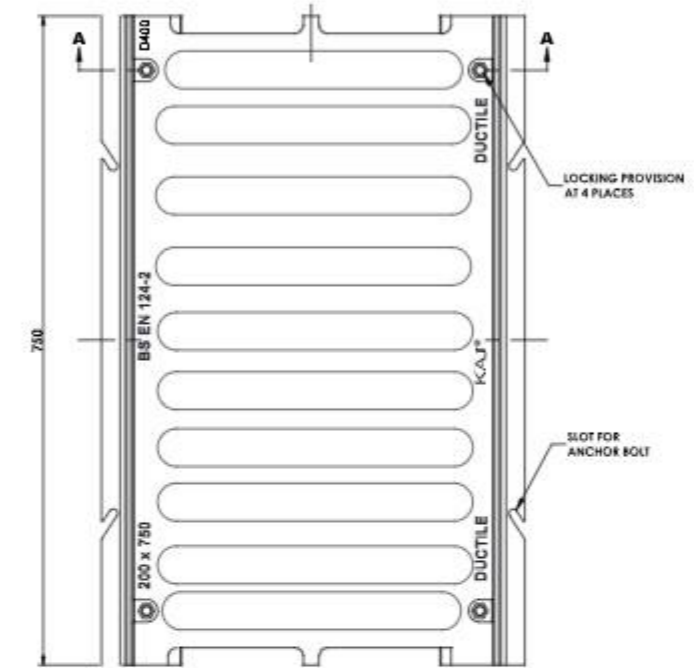

ASSEMBLY PLAN VIEW

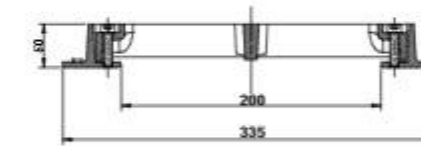

SECTION A-A

FEATURES:

1. Manufactured as per BS EN 124 -2 Design Standard
2. Can also be designed with a concealed locking mechanism for safer access
3. Load achieve before concrete filling
4. Designed to non-rock
5. Can be provisioned for Gasket and GRP seating
6. Custom Marking/ Logos available on request

REV. NO	DATE	MODIFICATION	NAME	DATE	SIGN.
			DRWN. BY:-	T.R.B	20.02.23
			CHKD. BY:-	R.Mukherjee	20.02.23
			APPRD. BY:-	T.R.B	20.02.23
			MATERIAL:-	DUCTILE IRON EN1563-500/7	
			TOLERANCE:-	ISO 8062 (CT-11)	
			BRAND:-	KAJ	
				LOAD:-	D400
				SCALE:-	NTS
				COAT:-	BLACK BITUMEN
					SHEET NO:- 1 OF 1
					DRG. NO. K 750 A

KAJ® KAJ BUILDING & CONSTRUCTION MATERIALS WHOLESALE TRADING LLC.
Registered Office: Plot Number: 629-G Building Name: ABRA CEMENT, Real Street - Dubai
E-mail: info@kajworld.com | Website: www.kajworld.com
Warehouse: INDUSTRIAL AREA 17 - Mirdas Street
Plot Number: 101, Government Land No. - 101, SAIBAN (DUB)

DRAWING DESCRIPTION:-

200X750 CHANNEL GRATING D400

300X750X75 D400 CHANNEL GRATING MANHOLE COVER WITH GRP SEALING PROVISION



D400 Channel Grating manufactured to BS-EN 124-2 Compliant skid resistant for high risk location



Anti-flex covers prevent the causes of cover seating wear, eliminating excessive noise and catastrophic failure.



Specially designed cover support geometry reduces movement relative to the frame, minimising seating wear.



Enlarged frame corners help to dissipate, load minimising bearing pressure.



Indexed corners ensure correct orientation first time, every time.



Inspection window allows safe and easy view into chamber.

300X750X75 D400 CHANNEL GRATING

S#	CLEAR OPENING AxA (MM)	OVER BASE BxB (MM)	TOTAL HEIGHT H (MM)	LOAD CLASS	FEATURES	KITE MARK
1	300 X 750	750x 435	75	D- 400	BOLD PROVISION	NO

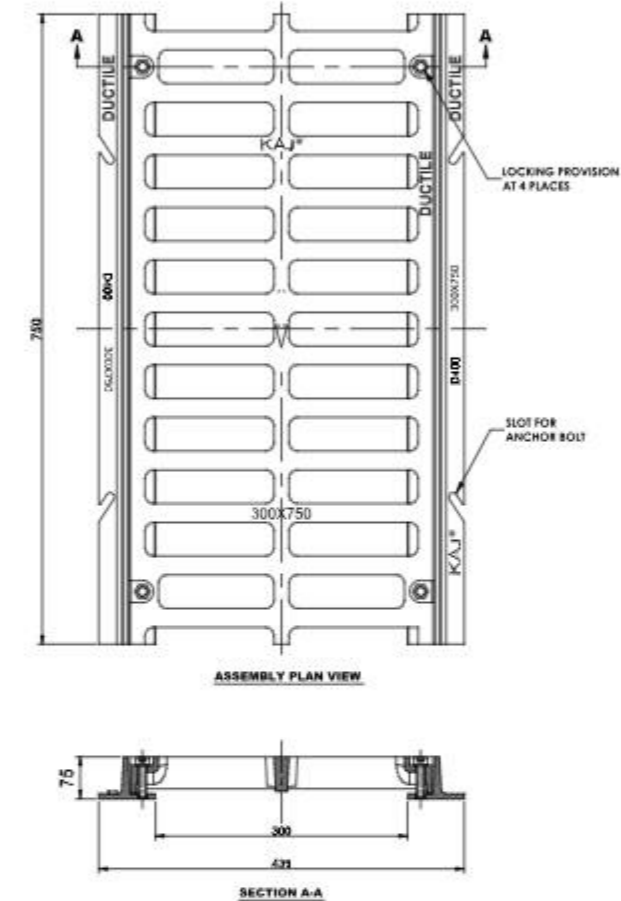

FEATURES:

1. Manufactured as per BS EN 124 -2 Design Standard
2. Can also be designed with a concealed locking mechanism for safer access
3. Load achieve before concrete filling
4. Designed to non-rock
5. Can be provisioned for Gasket and GRP seating
6. Custom Marking/ Logos available on request

REV. NO	DATE	MODIFICATION	NAME	DATE	SIGN.	KAJ® KAJ BUILDING MATERIAL PVT. LTD. <small>Registered Office: Plot Number: 101/10 Building Name: KAJ-1, Sector-10, Gurgaon - 122002 E-mail: info@kajworld.com Website: www.kajworld.com Warehouse - INDIA: 101/10 Building Name: KAJ-1, Sector-10, Gurgaon - 122002</small>
			DRWN. BY:-	T.R.B	20.02.23	
			CHKD. BY:-	R.Mukherjee	20.02.23	
			APPRD. BY:-	T.R.B	20.02.23	
			MATERIAL:-	DUCTILE IRON EN1563-500/7		
			TOLERANCE:-	ISO 8062 (CT-11)		
			BRAND:-	KAJ		
				LOAD:-	D400	
				SCALE:-	NTS	
			ALL DIMENSIONS ARE IN MM.			

SOLID TOP KERB GULLY COVER FRAME

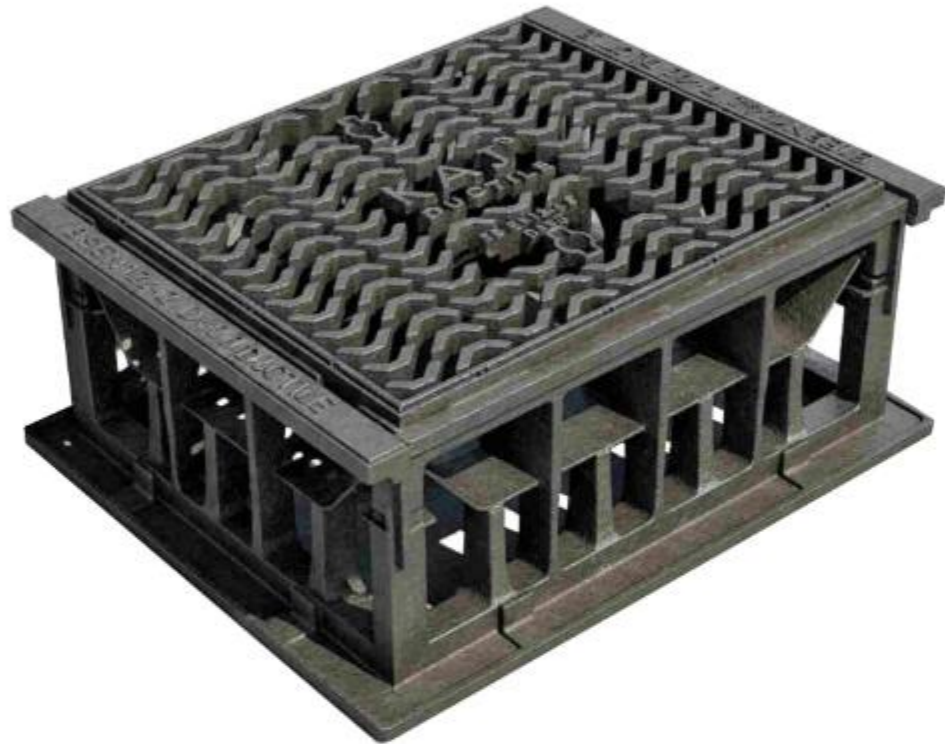

D400 Chanel Grating manufactured to BS-EN 124-2 Compliant skid resistant for high risk location



Anti-flex covers prevent the causes of cover seating wear, eliminating excessive noise and catastrophic failure.



Specially designed cover support geometry reduces movement relative to the frame, minimising seating wear.



Enlarged frame corners help to dissipate, load minimising bearing pressure.



Indexed corners ensure correct orientation first time, every time.



Inspection window allows safe and easy view into chamber.

SOLID TOP KERB GULLY COVER FRAME

S#	CLEAR OPENING AxA (MM)	OVER BASE BxB (MM)	TOTAL HEIGHT H (MM)	LOAD CLASS	FEATURES	KITE MARK
1	532X405	618 X 460	205	D- 400	BOLD PROVISION	NO

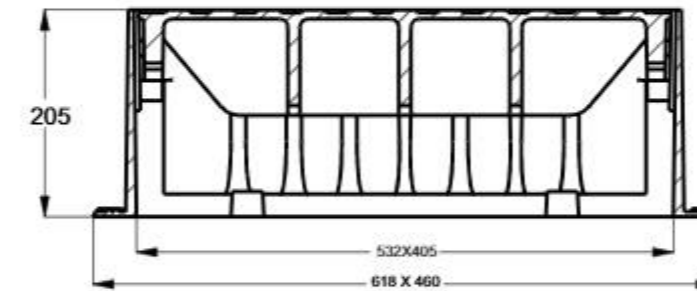
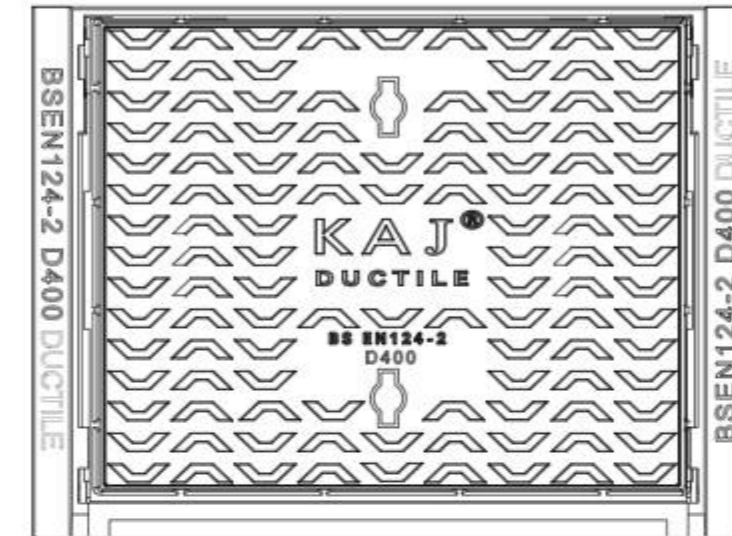

SECTION A-A

FEATURES:

1. Manufactured as per BS EN 124 -2 Design Standard
2. Can also be designed with a concealed locking mechanism for safer access
3. Load achieve before concrete filling
4. Designed to non-rock
5. Can be provisioned for Gasket and GRP seating
6. Custom Marking/ Logos available on request

REV. NO	DATE	MODIFICATION	NAME	DATE	SIGN.	KAJ® KAJ BUILDING MATERIAL PVT. LTD. <small>Registered Office: Plot Number: 1274 Building Name: A-102, G-1014, Bell Street - Gurgaon Email: info@kajworld.com Website: www.kajworld.com Workshop: 102/308, Phase 17, Sector 14, Gurgaon (HR)</small>	
			DRWN. BY:-	T.R.B	20.02.23	DRAWING DESCRIPTION:- SOLID TOP KERB GULLY COVER FRAME	
			CHKD. BY:-	R.Mukherjee	20.02.23		
			APPRD. BY:-	T.R.B	20.02.23		
			MATERIAL:- DUCTILE IRON EN1563-500/7			COAT:- BLACK BITUMEN	
			TOLERANCE:- ISO 8062 (CT-11)				
			BRAND:- KAJ			SHEET NO:- 1 OF 1	
			LOAD:- D400 SCALE:- NTS				
			ALL DIMENSIONS ARE IN MM.			DRG. NO. K-KG01	

GULLY GRATE FRAME & COVER



D400 Chanel Grating manufactured to BS-EN 124-2 Compliant skid resistant for high risk location



Anti-flex covers prevent the causes of cover seating wear, eliminating excessive noise and catastrophic failure.



Specially designed cover support geometry reduces movement relative to the frame, minimising seating wear.



Enlarged frame corners help to dissipate, load minimising bearing pressure.



Indexed corners ensure correct orientation first time, every time.



Inspection window allows safe and easy view into chamber.

GULLY GRATE FRAME & COVER

S#	CLEAR OPENING AxA (MM)	OVER BASE BxB (MM)	TOTAL HEIGHT H (MM)	LOAD CLASS	FEATURES	KITE MARK
1	390X320	410X480	100	D- 400	Hinged Cover	NO

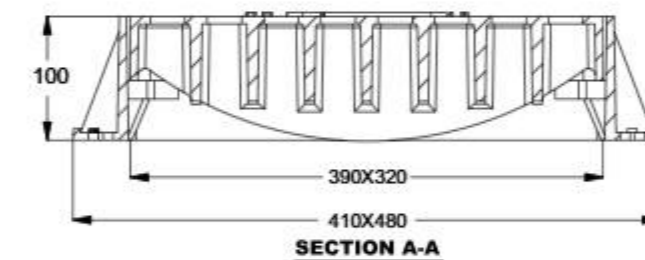
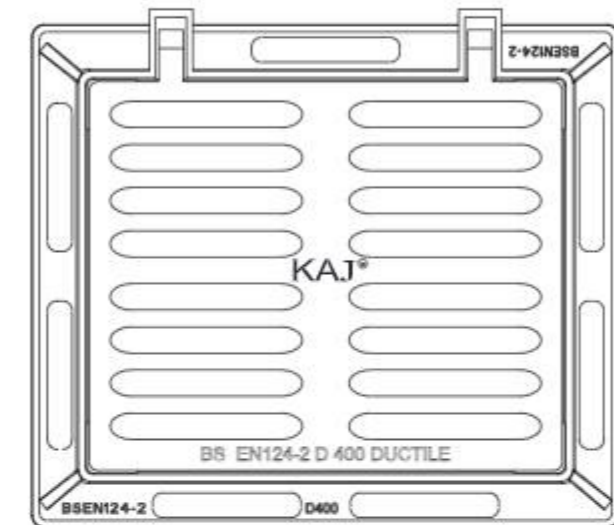

FEATURES:

1. Manufactured as per BS EN 124 -2 Design Standard
2. Can also be designed with a concealed locking mechanism for safer access
3. Load achieve before concrete filling
4. Designed to non-rock
5. Can be provisioned for Gasket and GRP seating
6. Custom Marking/ Logos available on request

REV. NO	DATE	MODIFICATION	NAME	DATE	SIGN.	KAJ® KAJ BUILDING MATERIAL PVT. LTD. <small>Regional Office: Plot Number: A/10 Building Name: KAJ, L/10/24, 4th Floor - Suba Email: info@kajworld.com Website: www.kajworld.com Warehouse: INDUSTRIAL AREA 17, Madhav Street Plot Number: 104, Government Land No.: 16, 200001 (2A)</small>	DRAWING DESCRIPTION:- GULLY GRATE FRAME & COVER	SHEET NO:- 1 OF 1 DRG. NO. K-KG02
			DRWN. BY:- T.R.B	20.02.23				
			CHKD. BY:- R.Mukherjee	20.02.23				
			APPRD. BY:- T.R.B	20.02.23				
			MATERIAL:- DUCTILE IRON EN1563-500/7					
			TOLERANCE:- ISO 8062 (CT-1)					
			BRAND:- KAJ					
				LOAD:- D400				
				SCALE:- NTS				
			ALL DIMENSIONS ARE IN MM.					

SOLID TOP RECTANGULAR COVER AND FRAME



D400 Chanel Grating manufactured to BS-EN 124-2 Compliant skid resistant for high risk location



Anti-flex covers prevent the causes of cover seating wear, eliminating excessive noise and catastrophic failure.



Specially designed cover support geometry reduces movement relative to the frame, minimising seating wear.



Enlarged frame corners help to dissipate, load minimising bearing pressure.



Indexed corners ensure correct orientation first time, every time.



Inspection window allows safe and easy view into chamber.

SOLID TOP RECTANGULAR COVER AND FRAME

S#	CLEAR OPENING AxA (MM)	OVER BASE BxB (MM)	TOTAL HEIGHT H (MM)	LOAD CLASS	FEATURES	KITE MARK
1	600 X 750	900 X 750	100	D- 400	Double Seal GRP Seal Provision	NO

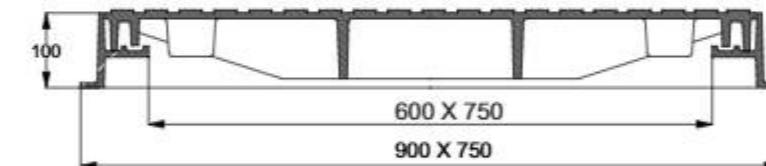
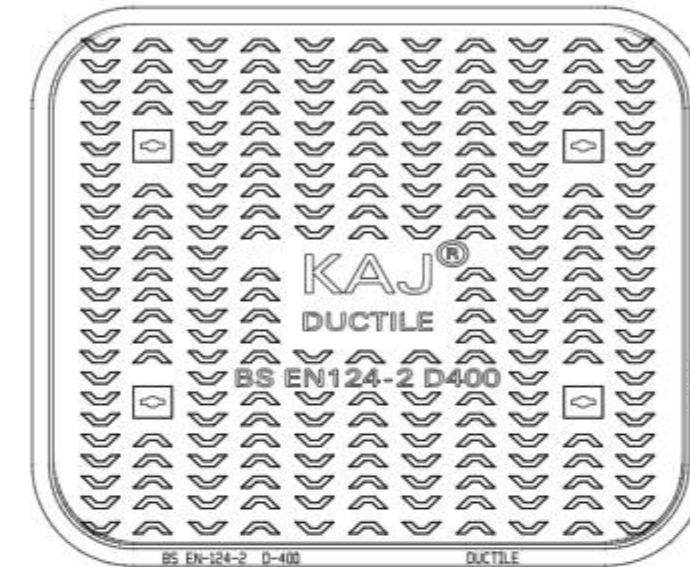

SECTION A-A

FEATURES:

1. Manufactured as per BS EN 124 -2 Design Standard
2. Can also be designed with a concealed locking mechanism for safer access
3. Load achieve before concrete filling
4. Designed to non-rock
5. Can be provisioned for Gasket and GRP seating
6. Custom Marking/ Logos available on request

REV. NO	DATE	MODIFICATION	NAME	DATE	SIGN.	KAJ® KAJ BUILDING MATERIAL PVT. LTD. <small>Regional Office: Plot Number: 10/10 Building Name: KAJ, Laxmi, New Town - 700016 Email: info@kajworld.com Website: www.kajworld.com Warehouse: INDUSTRIAL AREA I/1 Midnapore Plot Number: 108, Government Land No. - 104, 200001 (200)</small>	DRAWING DESCRIPTION:- SOLID TOP RECTANGULAR COVER AND FRAME	COAT:- BLACK BITUMEN SHEET NO:- 1 OF 1 DRG. NO. K-KG02
			DRWN. BY:- T.R.B	20.02.23				
			CHKD. BY:- R.Mukherjee	20.02.23				
			APPRD. BY:- T.R.B	20.02.23				
			MATERIAL:- DUCTILE IRON EN1563-500/7					
			TOLERANCE:- ISO 8062 (CT-11)					
			BRAND:- KAJ					
			LOAD:- D400 SCALE:- NTS					
ALL DIMENSIONS ARE IN MM.								

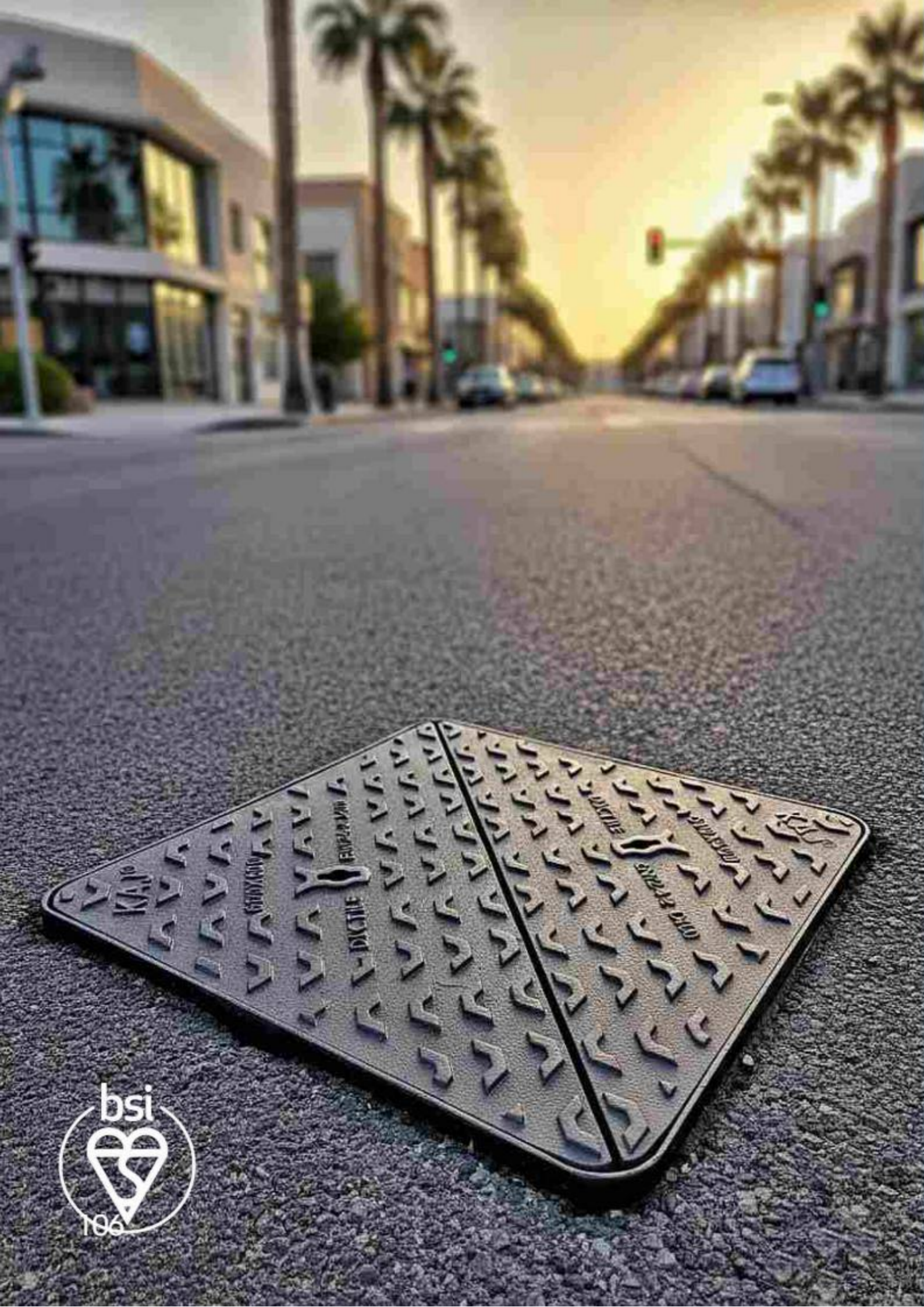

KAJ KITE MARK SERIES



**Built for the UAE.
Trusted Globally.**

DUCTILE IRON MANHOLE COVERS
The Mark of Strength & Durability



300 X 300 SERIES

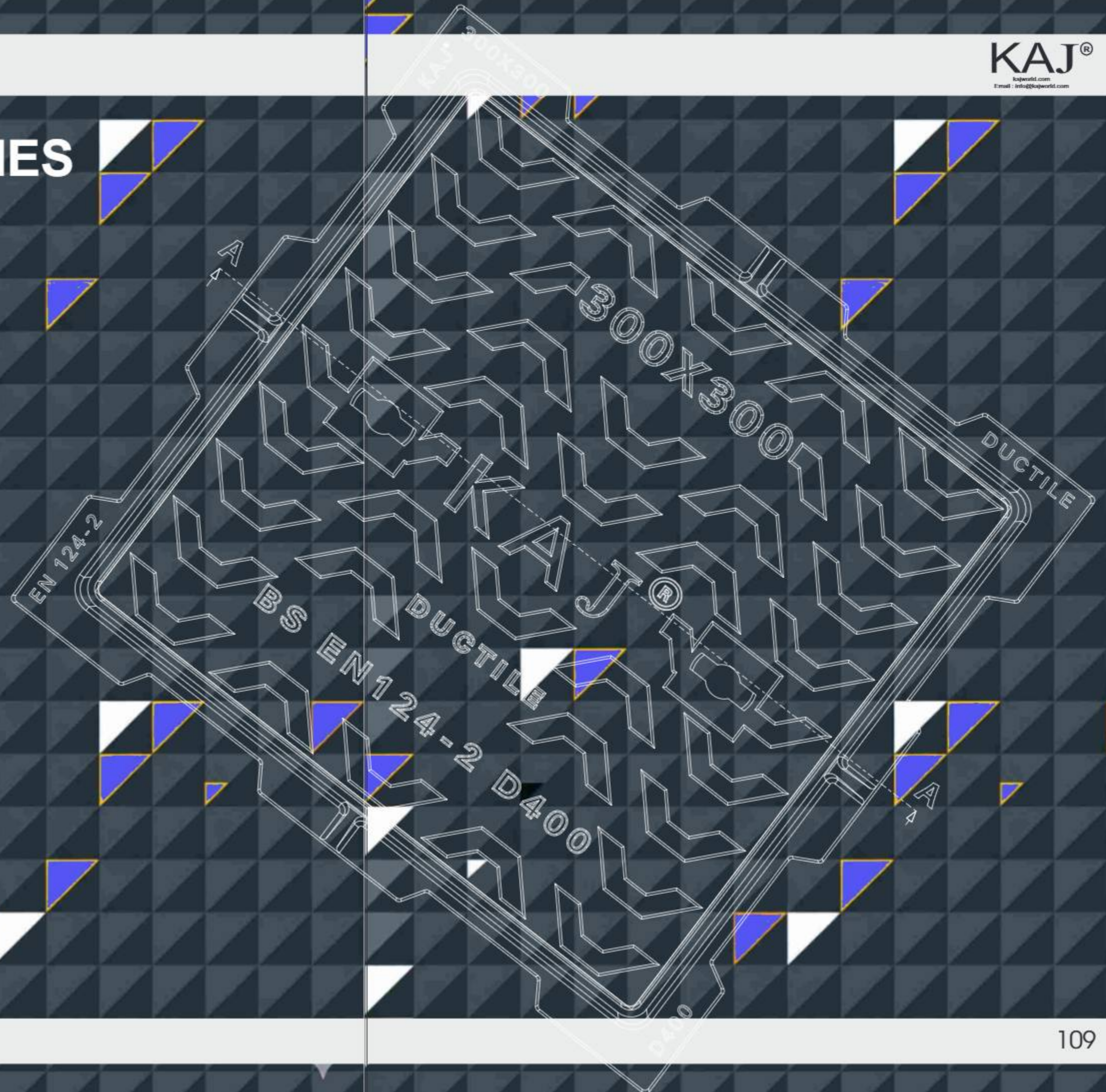

300X300X80 D 400 SOLID TOP MANHOLE COVER WITH GRP SEALING PROVISION

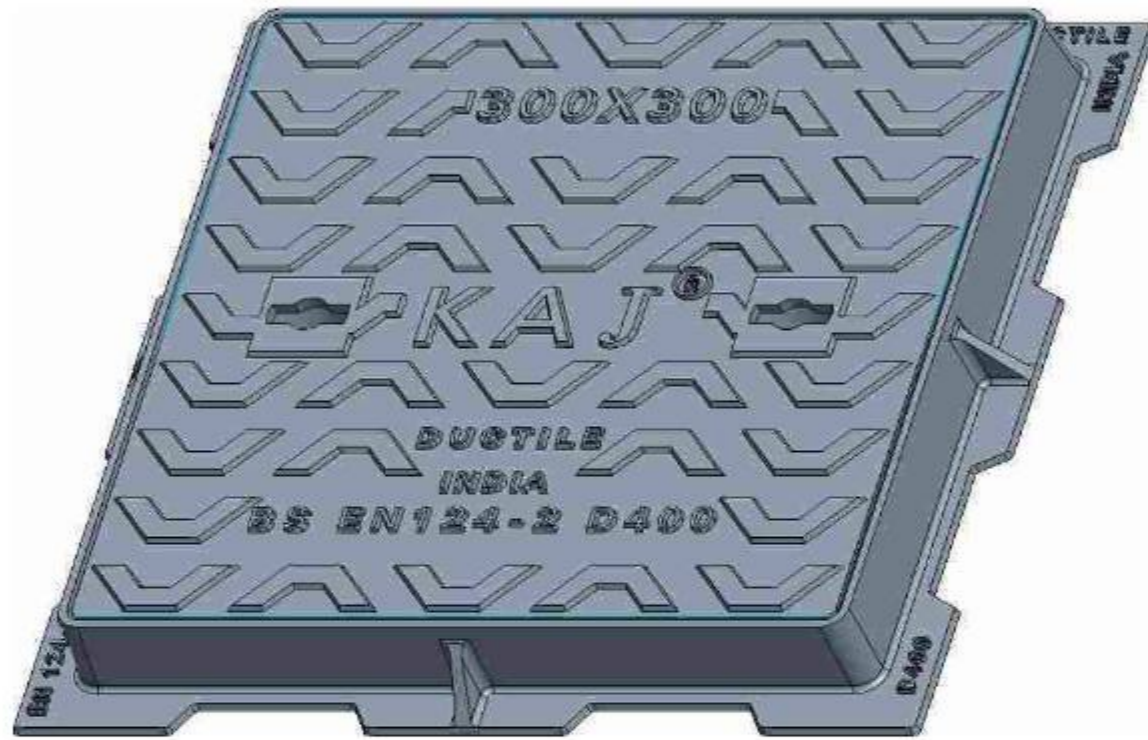



 D400 Kite Mark Manhole Covers manufactured to BS-EN 124-2 Compliant skid resistant for high risk location

 Anti-flex covers prevent the causes of cover seating wear, eliminating excessive noise and catastrophic failure.

 Specially designed cover support geometry reduces movement relative to the frame, minimising seating wear.

 Enlarged frame corners help to dissipate, load minimising bearing pressure.

 Indexed corners ensure correct orientation first time, every time.

 Inspection window allows safe and easy view into chamber.

300X300 X80 D 400 SOLID TOP COVER AND FRAME						
S#	CLEAR OPENING	OVER BASE	TOTAL HEIGHT	LOAD CLASS	FEATURES	KITE MARK
	AxA (MM)	BxB (MM)	H (MM)			
1	300 X 300	460 x 460	80	D- 400	Double Seal / GRP PROVISION	 YES

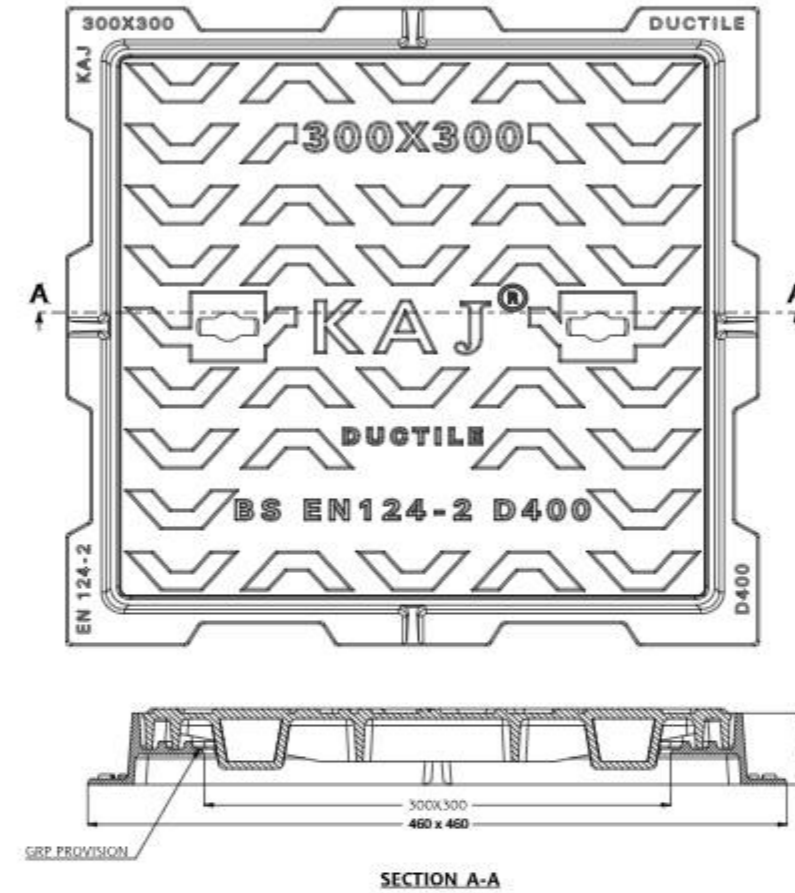

FEATURES:

1. In house, Load Test Pass Certificate shall be provided with all Kitemark products.
2. Manufactured as per BS EN 124 -2 Design Standard
3. Can also be designed with a concealed locking mechanism for safer access
4. Load achieve before concrete filling
5. Designed to non-rock
6. Can be provisioned for Gasket and GRP seating
7. Custom Marking/ Logos available on request

REV. NO	DATE	MODIFICATION	NAME	DATE	SIGN.
			DRWN. BY:-	T.R.B	20.02.23
			CHKD. BY:-	R.Mukherjee	20.02.23
			APPRD. BY:-	T.R.B	20.02.23
MATERIAL:- DUCTILE IRON EN1563-500/7					
TOLERANCE:- ISO 5062 (CT-11)					
BRAND:- KAJ					
 LOAD:- D400 SCALE:- NTS					
ALL DIMENSIONS ARE IN MM.					

KAJ® KAJ BUILDING & CONSTRUCTION MATERIALS WHOLESALE TRADING LLC.
 Registered Office: Plot Number: 629-0 Building Name: ABRAJ CENTER, Red Street - Daba
 Email: info@kajworld.com | Website: www.kajworld.com
 Warehouse: MEDICAL AREA-17, Madhav Street
 Plot Number: 705, Government Land No.: 305, SHAMBA (KAJ)

DRAWING DESCRIPTION:-
**300X300 SOLID TOP D400
 FRAME AND COVER (WITH GRP)**

COAT:- BLACK BITUMEN

SHEET NO:- 1 OF 1
 DRG. NO. **KK-3011A**

300X300X80 D400 RECESS TOP MANHOLE COVER WITH GRP SEALING PROVISION

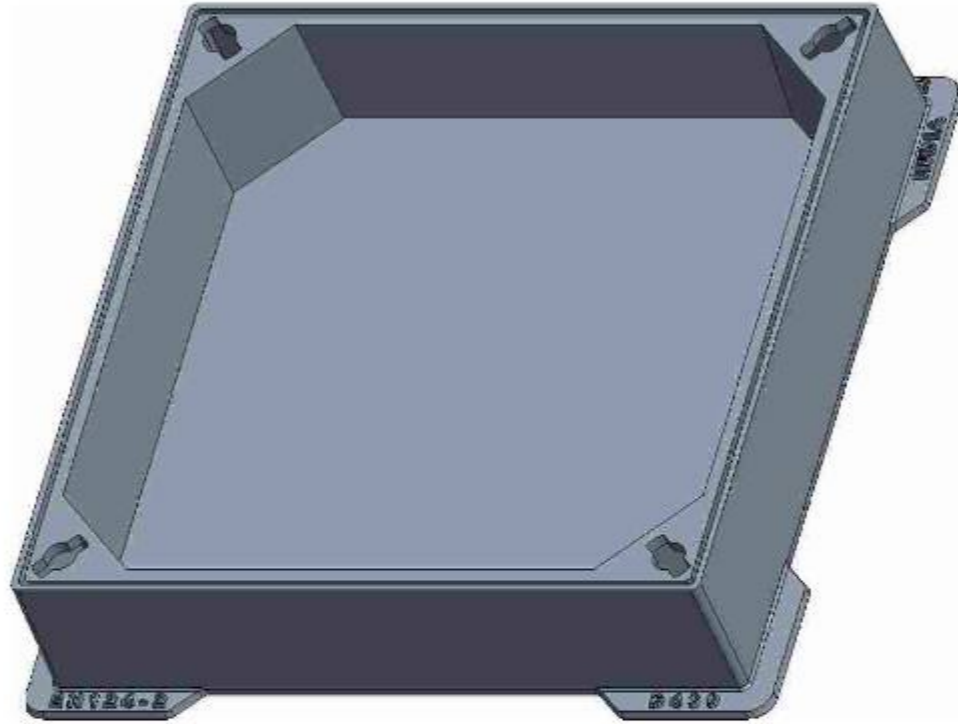

D400 Kite Mark Manhole Covers manufactured to BS-EN 124-2 Compliant skid resistant for high risk location



Anti-flex covers prevent the causes of cover seating wear, eliminating excessive noise and catastrophic failure.



Specially designed cover support geometry reduces movement relative to the frame, minimising seating wear.



Enlarged frame corners help to dissipate, load minimising bearing pressure.



Indexed corners ensure correct orientation first time, every time.



Inspection window allows safe and easy view into chamber.

300X30 X80 RECESS TOP COVER & FRAME D 400

S#	CLEAR OPENING AxA (MM)	OVER BASE BxB (MM)	TOTAL DEPTH H (MM)	RECESSED DEPTH R (MM)	LOAD CLASS	FEATURES	KITE MARK
1	300 X 300	440 x 440	95	80	D - 400	Double Seal / GRP Provision	YES

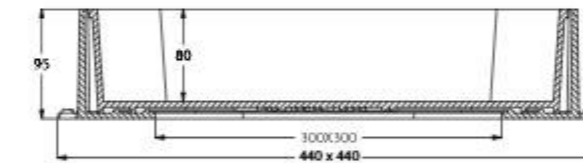
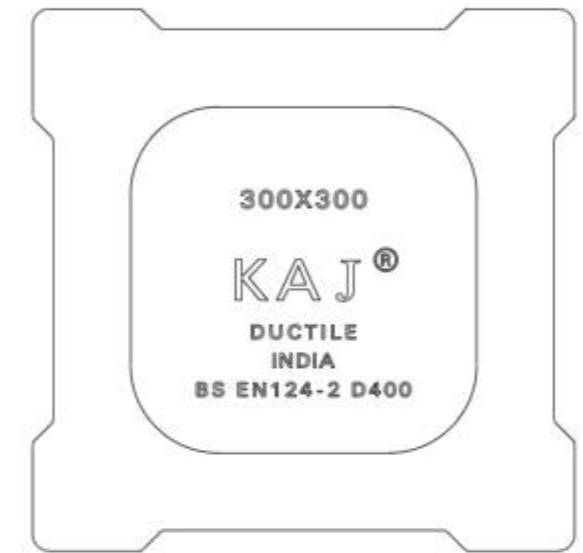
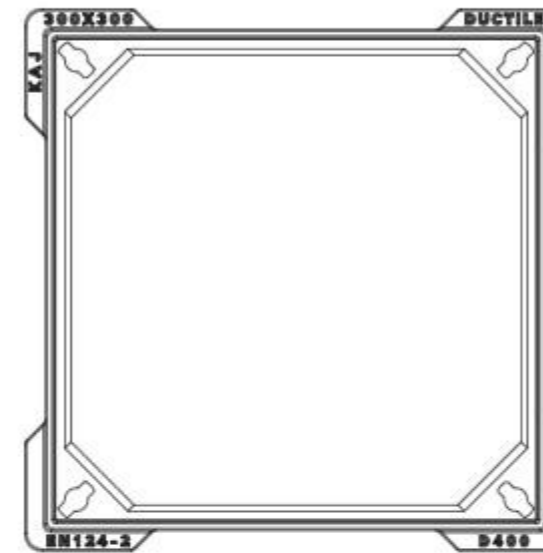

FEATURES:

1. In house, Load Test Pass Certificate shall be provided with all Kitemark products.
2. Manufactured as per BS EN 124 -2 Design Standard
3. Can also be designed with a concealed locking mechanism for safer access
4. Load achieve before concrete filling
5. Designed to non-rock
6. Can be provisioned for Gasket and GRP seating
7. Custom Marking/ Logos available on request

REV. NO	DATE	MODIFICATION	NAME	DATE	SIGN.	KAJ® KAJ BUILDING & CONSTRUCTION MATERIALS WHOLESALE TRADING LLC. Registered Office/Plot Number: 629-D Building Name: ARUN CENTER, Mal Street - Dabai Email: info@kajworld.com / Website: www.kajworld.com Warehouse: BOSTON AREA 17- Malha Street Plot Number: 191, Government Land No. 142, SARAJEVO (BOSNIA)
			DRWN. BY:-	T.R.B	20.02.23	
			CHKD. BY:-	R.Mukherjee	20.02.23	
			APPRD. BY:-	T.R.B	20.02.23	
			MATERIAL:-	DUCTILE IRON EN1563-500/7		
			TOLERANCE:-	ISO 8062 (CT-11)		
			BRAND:-	KAJ		
				LOAD:-	D400	
				SCALE:-	NTS	
			ALL DIMENSIONS ARE IN MM.			

300X300X50 D400 GULLY GRATE MANHOLE COVER

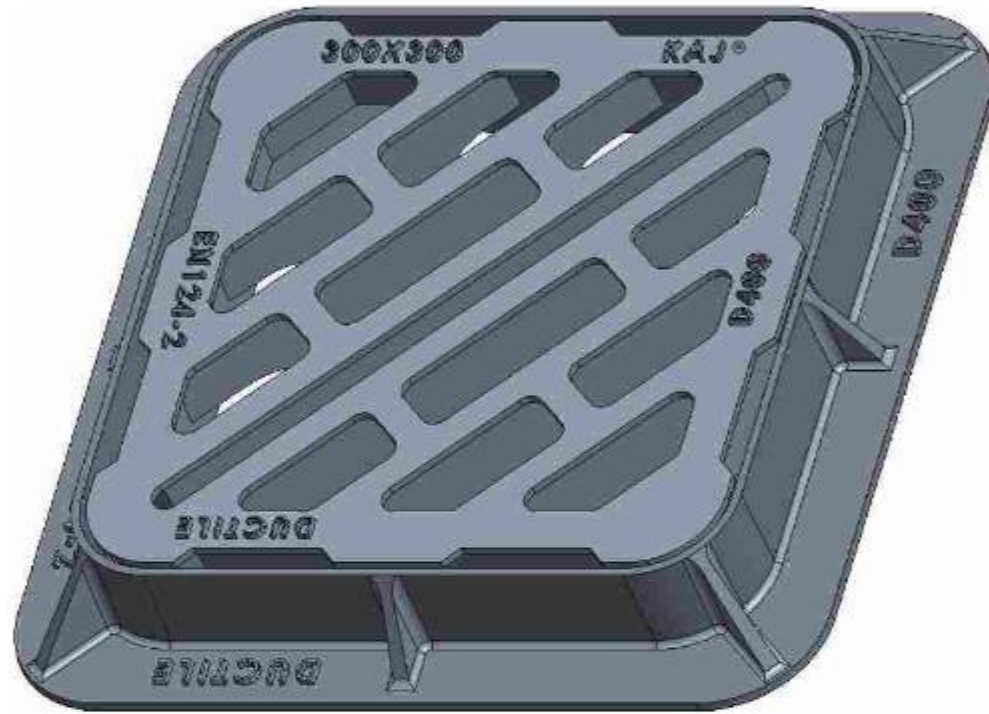

D400 Kite Mark Manhole Covers manufactured to BS-EN 124-2 Compliant skid resistant for high risk location



Anti-flex covers prevent the causes of cover seating wear, eliminating excessive noise and catastrophic failure.



Specially designed cover support geometry reduces movement relative to the frame, minimising seating wear.



Enlarged frame corners help to dissipate, load minimising bearing pressure.



Indexed corners ensure correct orientation first time, every time.



Inspection window allows safe and easy view into chamber.

300X300X50 D400 GULLY GRATE						
S#	CLEAR OPENING AxA (MM)	OVER BASE BxB (MM)	TOTAL HEIGHT H (MM)	LOAD CLASS	FEATURES	KITE MARK
1	300 X 300	410 x 410	50	D - 400	Single Seal	YES

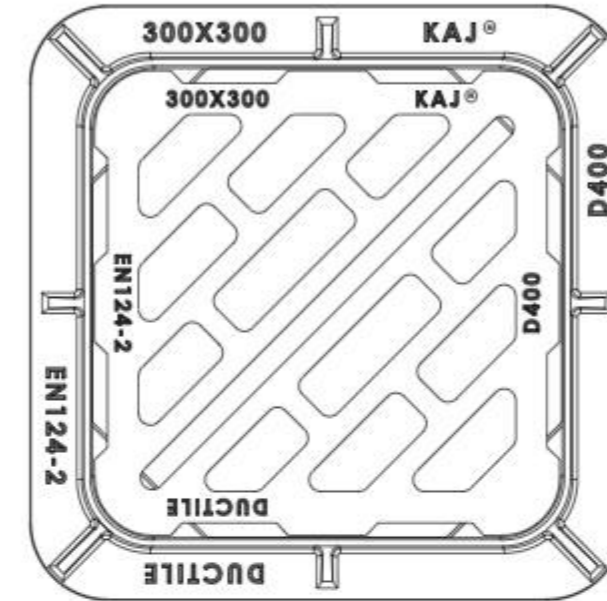

TOP VIEW

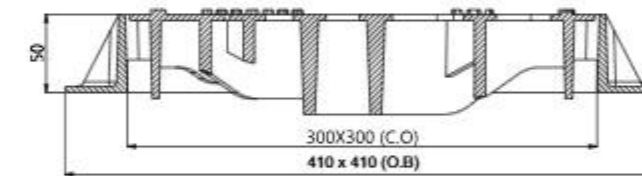

SECTION VIEW

FEATURES:

1. In house, Load Test Pass Certificate shall be provided with all Kitemark products.
2. Manufactured as per BS EN 124 -2 Design Standard
3. Can also be designed with a concealed locking mechanism for safer access
4. Load achieve before concrete filling
5. Designed to non-rock
6. Can be provisioned for Gasket and GRP seating
7. Custom Marking/ Logos available on request

REV. NO	DATE	MODIFICATION	NAME	DATE	SIGN.	KAJ® KAJ BUILDING & CONSTRUCTION MATERIALS WHOLESALE TRADING LLC. Registered Office: Plot Number - 429-2 Building Name - ABAJ (2) WILE, 1st Street - Dubai Email : info@kajworld.com Website : www.kajworld.com Warehouse : INDUSTRIAL AREA 17 - Madha Street Plot Number : 193, Government Land No. : 101, SARJAN (BAJ)
			DRWN. BY:-	T.R.B	20.02.23	
			CHKD. BY:-	R.Mukherjee	20.02.23	
			APPRD. BY:-	T.R.B	20.02.23	COAT:- BLACK BITUMEN SHEET NO:- 1 OF 1 DRG. NO. KK-3013A
			MATERIAL:- DUCTILE IRON EN1563-500/7			
			TOLERANCE:- ISO 8062 (CT-11)			
			BRAND:- KAJ			
			LOAD:- D400 SCALE:- NTS			
			ALL DIMENSIONS ARE IN MM.			

450 X 450 SERIES

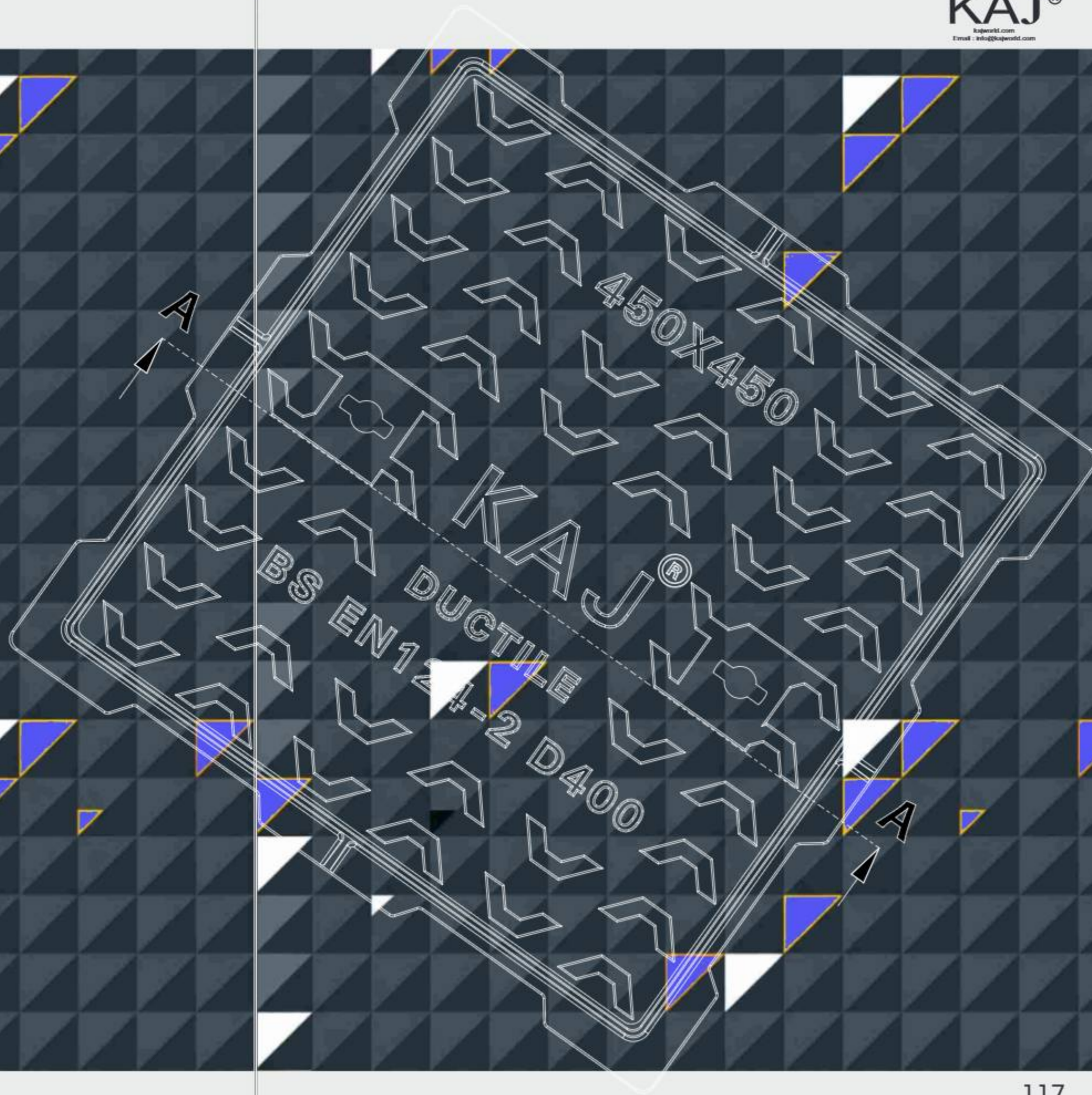

450X450X75 D400 SOLID TOP MANHOLE COVER WITH GRP SEALING PROVISION

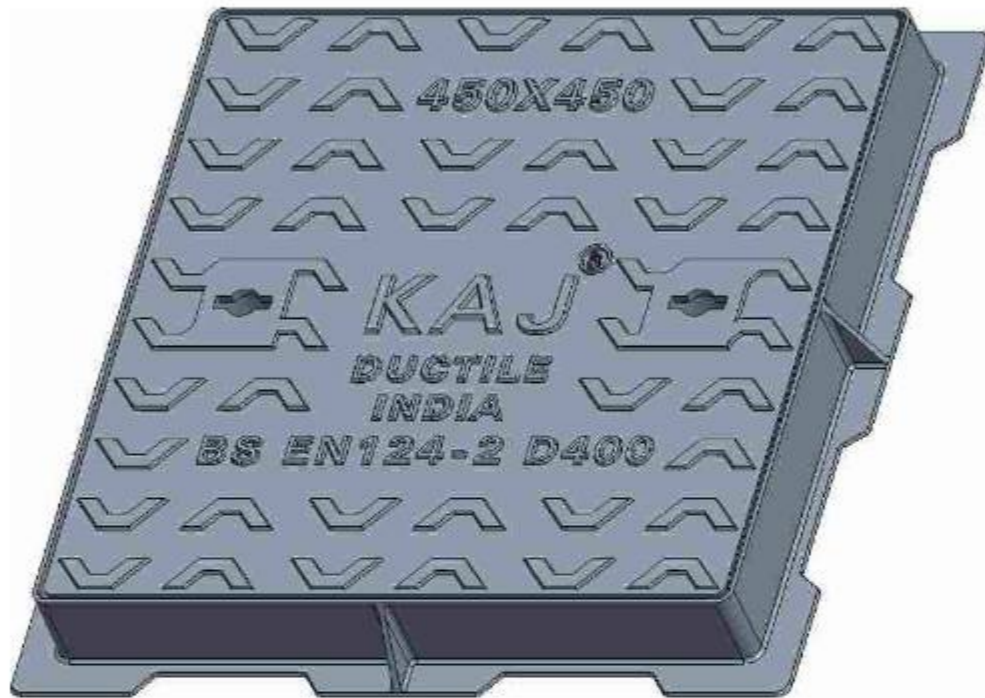

D400 Kite Mark Manhole Covers manufactured to BS-EN 124-2 Compliant skid resistant for high risk location



Anti-flex covers prevent the causes of cover seating wear, eliminating excessive noise and catastrophic failure.



Specially designed cover support geometry reduces movement relative to the frame, minimising seating wear.



Enlarged frame corners help to dissipate, load minimising bearing pressure.



Indexed corners ensure correct orientation first time, every time.



Inspection window allows safe and easy view into chamber.

450X450X75 D 400 SOLID TOP COVER AND FRAME						
S#	CLEAR OPENING	OVER BASE	TOTAL HEIGHT	LOAD CLASS	FEATURES	KITE MARK
	AxA (MM)	BxB (MM)	H (MM)			
1	450 X 450	630 x 630	75	D- 400	Double Seal / GRP PROVISION	YES

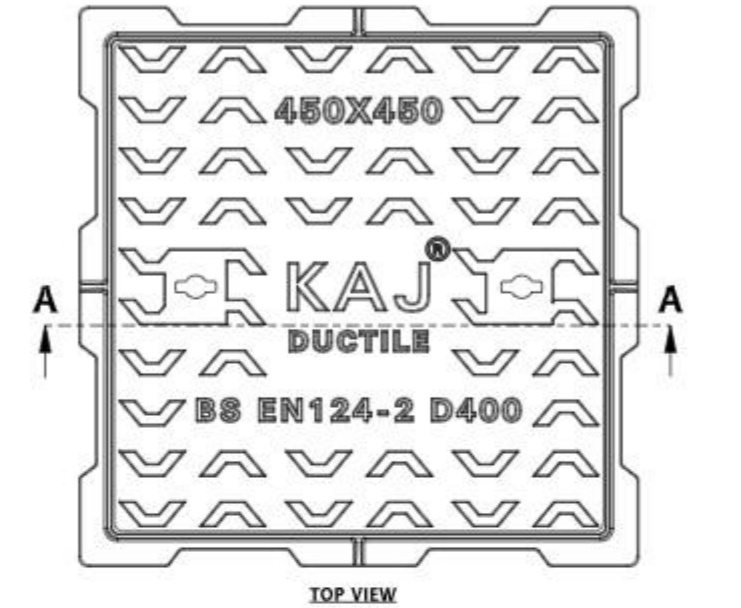

TOP VIEW

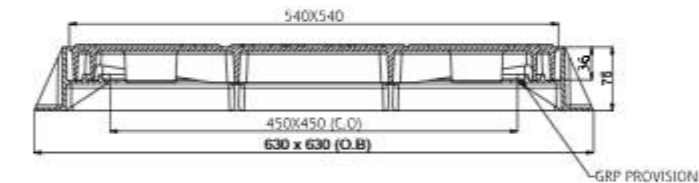

FRONT VIEW
 SECTION "A - A"

FEATURES:

1. In house, Load Test Pass Certificate shall be provided with all Kitemark products.
2. Manufactured as per BS EN 124 -2 Design Standard
3. Can also be designed with a concealed locking mechanism for safer access
4. Load achieve before concrete filling
5. Designed to non-rock
6. Can be provisioned for Gasket and GRP seating
7. Custom Marking/ Logos available on request

REV. NO	DATE	MODIFICATION	NAME	DATE	SIGN.	KAJ® KAJ BUILDING & CONSTRUCTION MATERIALS WHOLESALE TRADING LLC. Registered Office: Plot Number: 129-1 Building Name: ABRAJ CENTER, Main Street - Dabra Email: info@kajworld.com / Website: www.kajworld.com Warehouse: INDUSTRIAL AREA 17, Malvi Street Plot Number: 101, Government Land No.: 301, SHARAD (RAJ)
			DRWN. BY:-	T.R.B	20.02.23	
			CHKD. BY:-	R.Mukherjee	20.02.23	
			APPRD. BY:-	T.R.B	20.02.23	
			MATERIAL:-	DUCTILE IRON EN1563-500/7		
			TOLERANCE:-	ISO 8062 (CT-11)		
			BRAND:-	KAJ		
				LOAD:-	D400	
				SCALE:-	NTS	
			ALL DIMENSIONS ARE IN MM.			

450X450 X100 D400 RECESS TOP MANHOLE COVER WITH GRP SEALING PROVISION

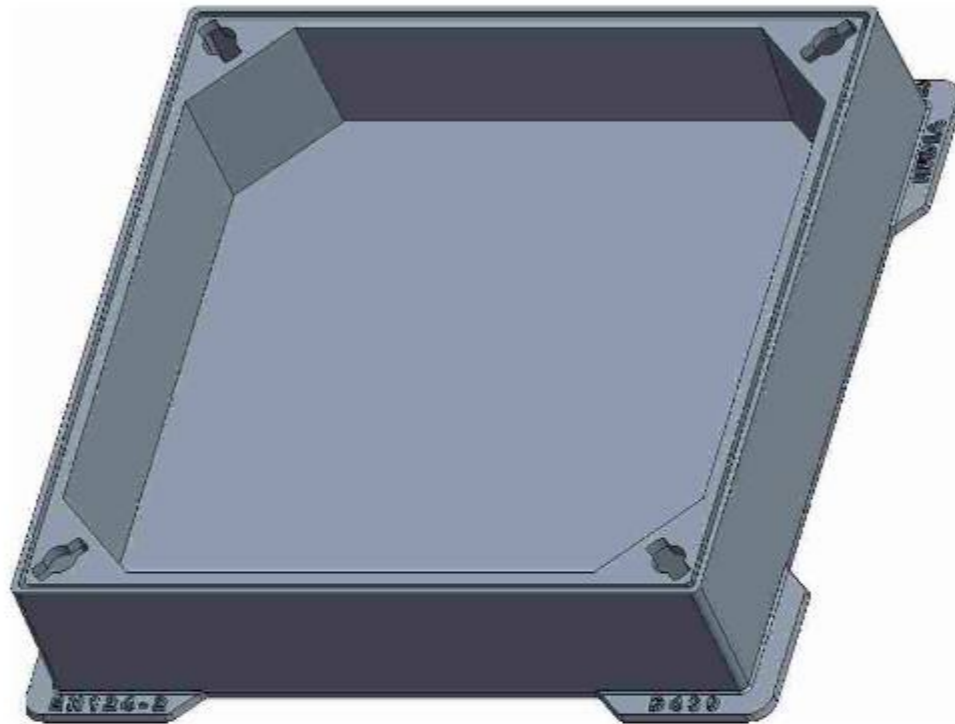

450 X 450 X 100 RECESS TOP COVER & FRAME D 400							
S#	CLEAR OPENING AxA (MM)	OVER BASE BxB (MM)	TOTAL DEPTH H (MM)	RECESSED DEPTH R (MM)	LOAD CLASS	FEATURES	KITE MARK
1	450 X 450	650 x 650	100	80	D - 400	Double Seal/ GRP PROVISION	YES

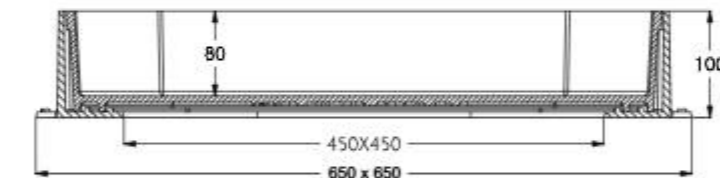
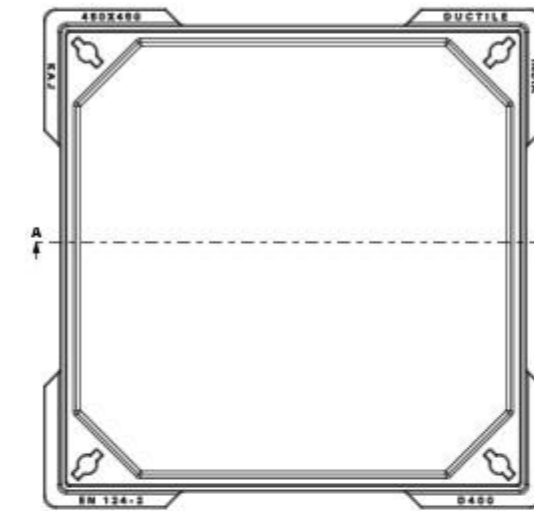

SECTION A-A

FEATURES:

1. In house, Load Test Pass Certificate shall be provided with all Kitemark products.
2. Manufactured as per BS EN 124 -2 Design Standard
3. Can also be designed with a concealed locking mechanism for safer access
4. Load achieve before concrete filling
5. Designed to non-rock
6. Can be provisioned for Gasket and GRP seating
7. Custom Marking/ Logos available on request



D400 Kite Mark Manhole Covers manufactured to BS-EN 124-2 Compliant skid resistant for high risk location



Anti-flex covers prevent the causes of cover seating wear, eliminating excessive noise and catastrophic failure.



Specially designed cover support geometry reduces movement relative to the frame, minimising seating wear.



Enlarged frame corners help to dissipate, load minimising bearing pressure.



Indexed corners ensure correct orientation first time, every time.



Inspection window allows safe and easy view into chamber.

REV. NO	DATE	MODIFICATION	NAME	DATE	SIGN.	KAJ® KAJ BUILDING & CONSTRUCTION MATERIALS WHOLESALE TRADING LLC. <small>Registered Office: Plot Number: 625-0 Building Name: ABRAU CENTER, Main Street - Dubai Email: info@kajworld.com / Website: www.kajworld.com Warehouse: MEDIAN AREA 17 - Media Street Plot Number: 708, Government Land No. : 302, SHARAH (JAF)</small>
			DRWN. BY:-	T.R.B	20.02.23	
			CHKD. BY:-	R.Mukherjee	20.02.23	
			APPRD. BY:-	T.R.B	20.02.23	
			MATERIAL:-	DUCTILE IRON EN1563-500/7		
			TOLERANCE:-	ISO 8062 (CT-11)		
			BRAND:-	KAJ		
				LOAD:-	D400	
				SCALE:-	NTS	
			ALL DIMENSIONS ARE IN MM.			

450X450X80 D400 GULLY GRATE MANHOLE COVER

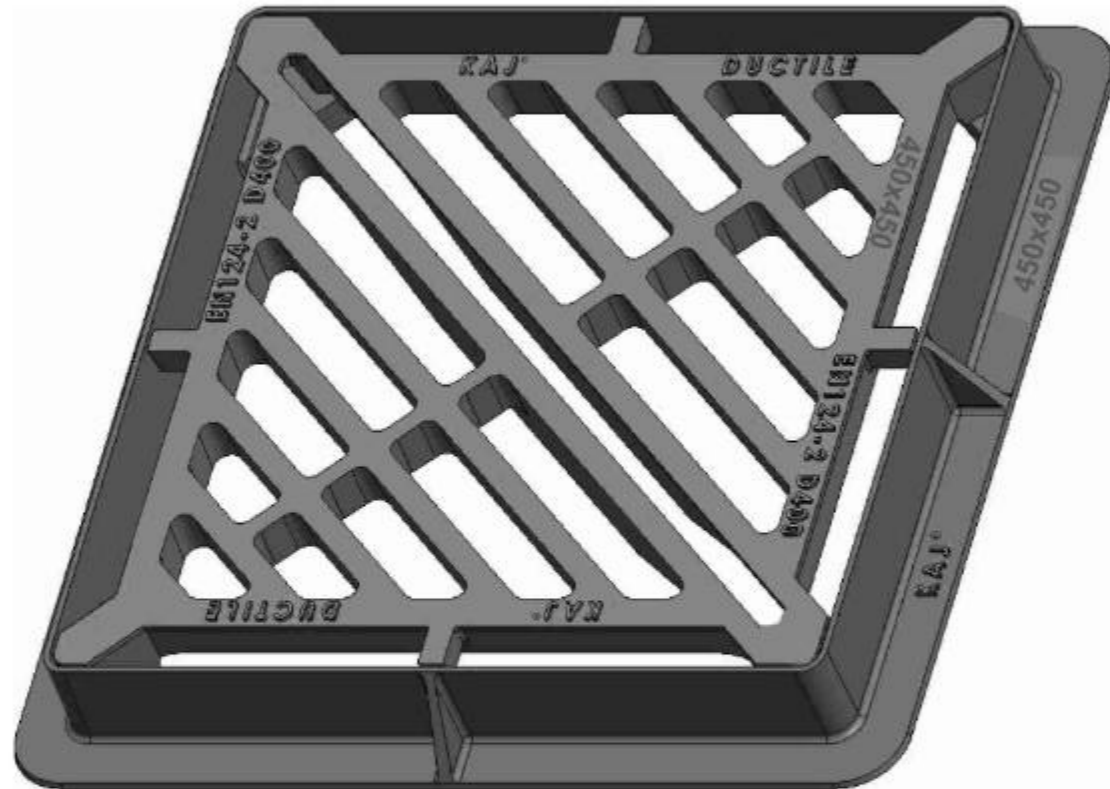

D400 Kite Mark Manhole Covers manufactured to BS-EN 124-2 Compliant skid resistant for high risk location



Anti-flex covers prevent the causes of cover seating wear, eliminating excessive noise and catastrophic failure.



Specially designed cover support geometry reduces movement relative to the frame, minimising seating wear.



Enlarged frame corners help to dissipate, load minimising bearing pressure.



Indexed corners ensure correct orientation first time, every time.



Inspection window allows safe and easy view into chamber.

450X450 X80 D400 GULLY GRATE D 400						
S#	CLEAR OPENING AxA (MM)	OVER BASE BxB (MM)	TOTAL HEIGHT H (MM)	LOAD CLASS	FEATURES	KITE MARK
1	450 X 450	550 x 550	100	D - 400	Single Seal	YES

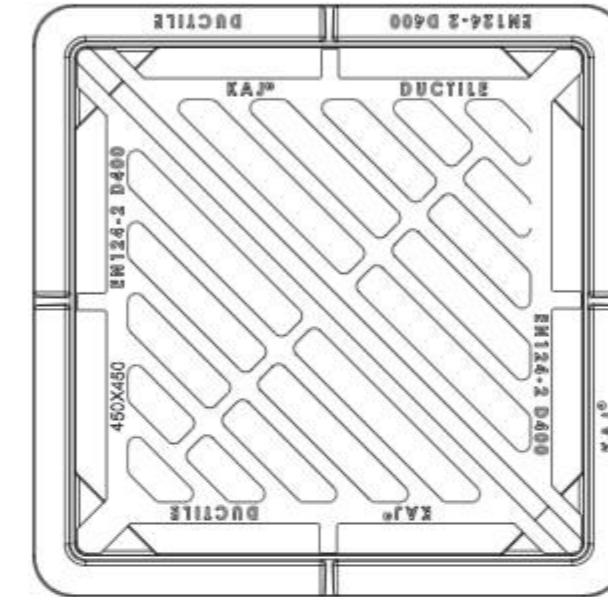

TOP VIEW

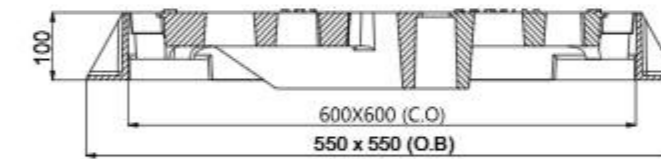

SECTION VIEW

FEATURES:

1. In house, Load Test Pass Certificate shall be provided with all Kitemark products.
2. Manufactured as per BS EN 124 -2 Design Standard
3. Can also be designed with a concealed locking mechanism for safer access
4. Load achieve before concrete filling
5. Designed to non-rock
6. Can be provisioned for Gasket and GRP seating
7. Custom Marking/ Logos available on request

REV. NO	DATE	MODIFICATION	NAME	DATE	SIGN.	KAJ® KAJ BUILDING & CONSTRUCTION MATERIALS WHOLESALE TRADING LLC. <small>Registered Office: Plot Number: 125-B Building Name: ARBA CENTER, Main Street - Dabra Email: info@kajworld.com Website: www.kajworld.com Warehouse: MIDC AREA 17- Malha Street Plot Number: 151, Government Land No.: 141, SARANI (S&Z)</small>	
			DRWN. BY:-	T.R.B	20.02.23	DRAWING DESCRIPTION:- 450X450 D400 GULLY GRATE S/S COAT:- BLACK BITUMEN SHEET NO:- 1 OF 1 DRG. NO. KK-4013A	
			CHKD. BY:-	R.Mukherjee	20.02.23		
			APPRD. BY:-	T.R.B	20.02.23		
			MATERIAL:-	DUCTILE IRON EN1563-500/7			
			TOLERANCE:-	ISO 8062 (CT-11)			
			BRAND:-	KAJ			
						LOAD:-	D400
						SCALE:-	NTS
						ALL DIMENSIONS ARE IN MM.	

600 X 600 SERIES

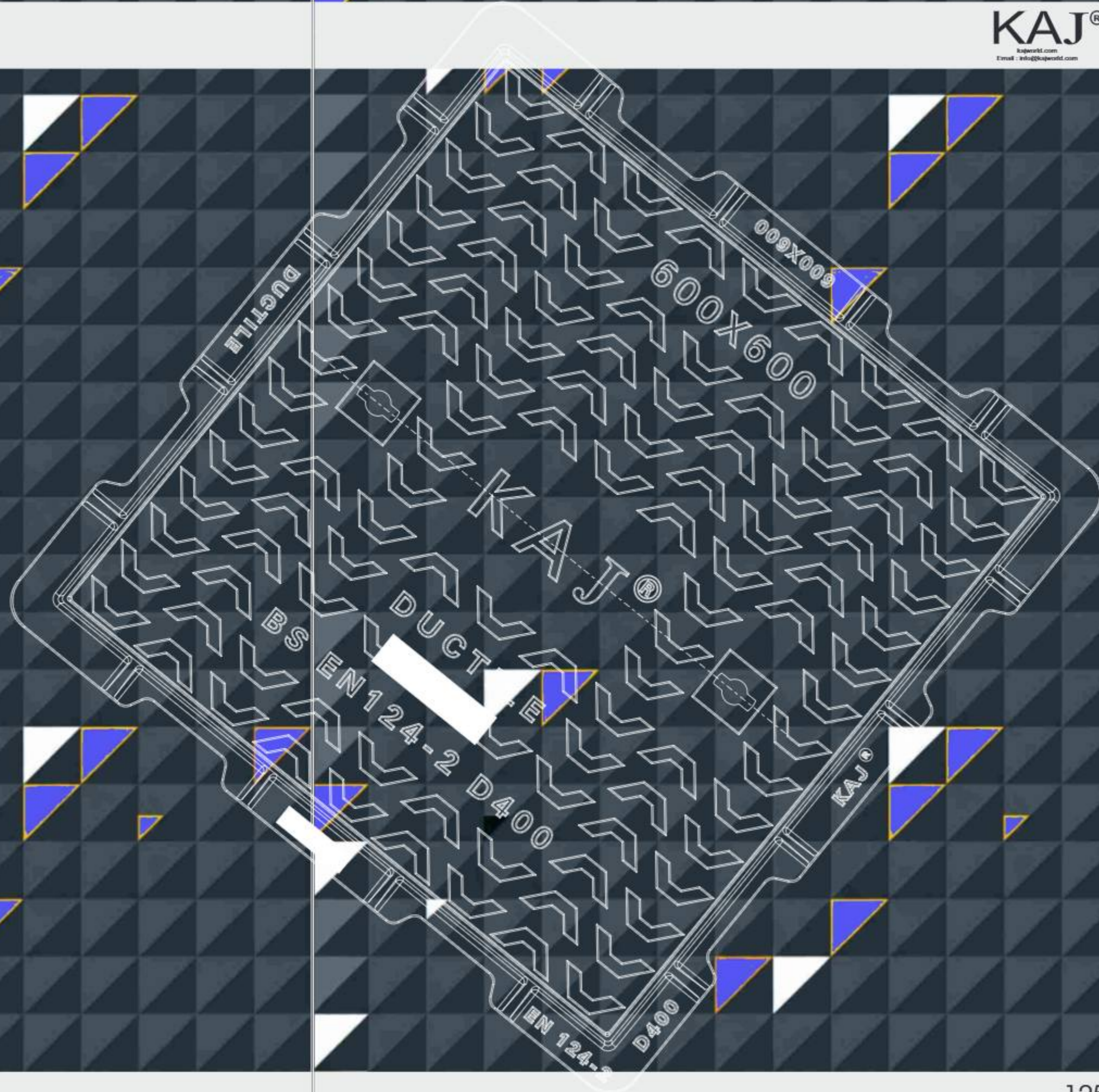

600X600 X100 D 400 SOLID TOP MANHOLE COVER WITH GRP SEALING PROVISION

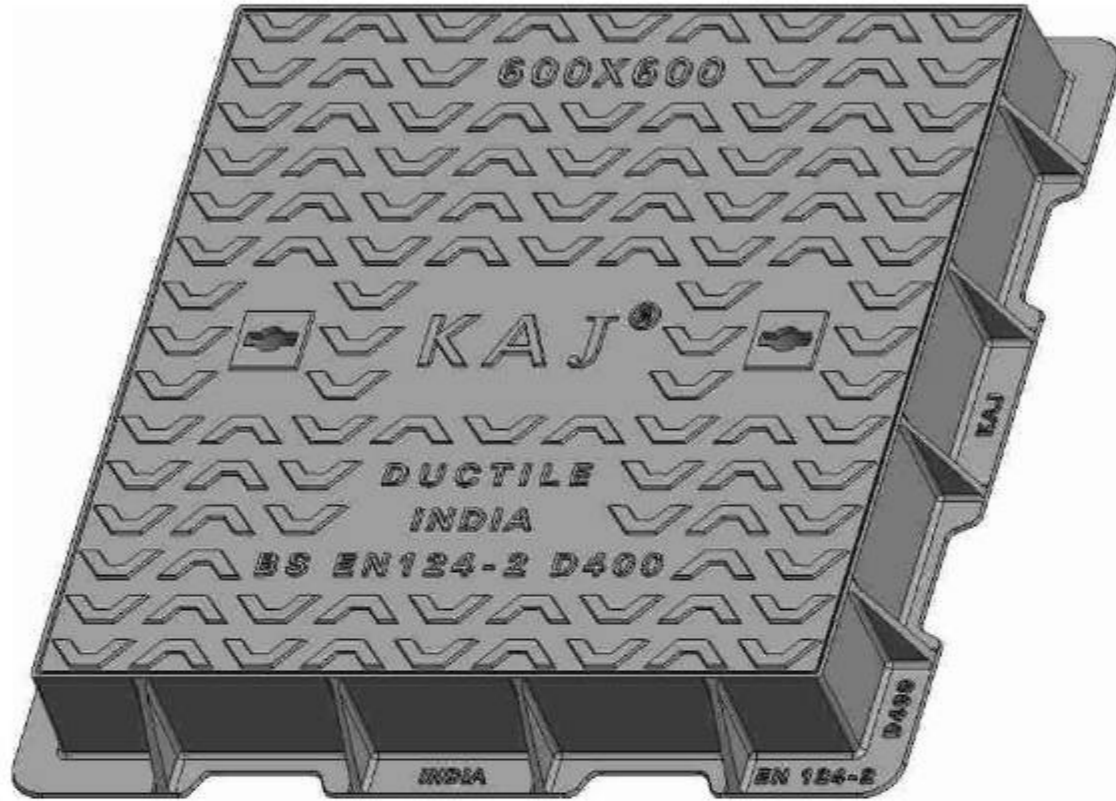

D400 Kite Mark Manhole Covers manufactured to BS-EN 124-2 Compliant skid resistant for high risk location



Anti-flex covers prevent the causes of cover seating wear, eliminating excessive noise and catastrophic failure.



Specially designed cover support geometry reduces movement relative to the frame, minimising seating wear.



Enlarged frame corners help to dissipate, load minimising bearing pressure.



Indexed corners ensure correct orientation first time, every time.



Inspection window allows safe and easy view into chamber.

600X600 X100 D 400 SOLID TOP COVER AND FRAME						
S#	CLEAR OPENING AxA (MM)	OVER BASE BxB (MM)	TOTAL HEIGHT H (MM)	LOAD CLASS	FEATURES	KITE MARK
1	600 X 600	780 x 780	100	D- 400	Double Seal/ GRP PROVISION	YES

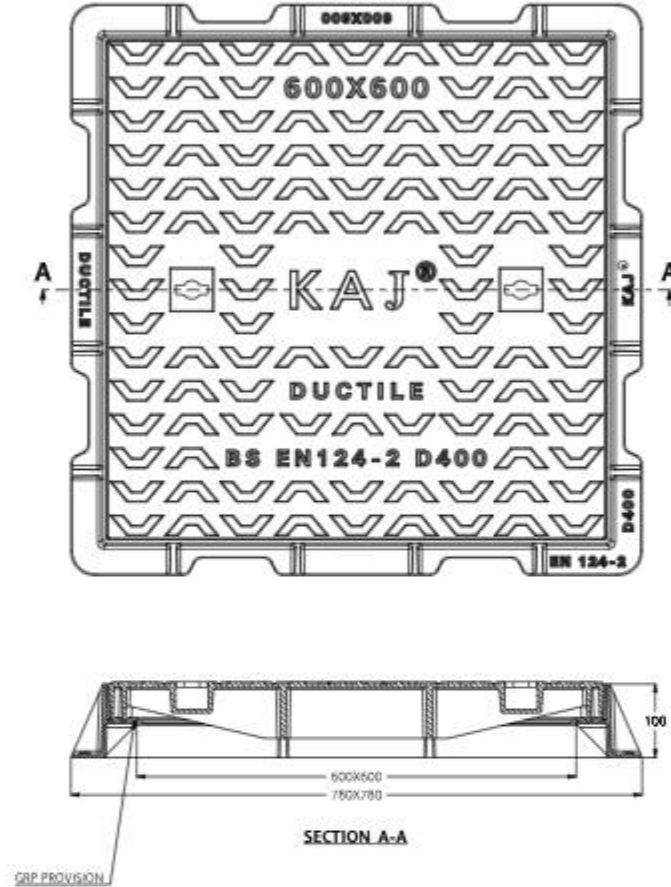

FEATURES:

1. In house, Load Test Pass Certificate shall be provided with all Kitemark products.
2. Manufactured as per BS EN 124 -2 Design Standard
3. Can also be designed with a concealed locking mechanism for safer access
4. Load achieve before concrete filling
5. Designed to non-rock
6. Can be provisioned for Gasket and GRP seating
7. Custom Marking/ Logos available on request

REV. NO	DATE	MODIFICATION	NAME	DATE	SIGN.
			DRWN. BY:-	T.R.B	20.02.23
			CHKD. BY:-	R.Mukherjee	20.02.23
			APPRD. BY:-	T.R.B	20.02.23
			MATERIAL:-	DUCTILE IRON EN1563-500/7	
			TOLERANCE:-	ISO 8062 (CT-11)	
			BRAND:-	KAJ	
				LOAD:-	D400
				SCALE:-	NTS
			ALL DIMENSIONS ARE IN MM.		

KAJ[®] KAJ BUILDING & CONSTRUCTION MATERIALS WHOLESALE TRADING LLC.
Registered Office: Plot Number: 535-2 Building Name: ABHI CENTER, Near Street - Dabul
 Email: info@kajworld.com | Website: www.kajworld.com
 Warehouse: INCORPORATED AREA 17- Malda Street
 Plot Number: 791, Government Land No. 101, SIKHARAJ (GATE)

DRAWING DESCRIPTION:-
**600X600 SOLID TOP D400
 FRAME AND COVER (WITH GRP)**

COAT:- BLACK BITUMEN

SHEET NO:- 1 OF 1

DRG. NO. **KK-6011A**

600X600X80 D 400 RECESS TOP MANHOLE COVER WITH GRP SEALING PROVISION





 D400 Kite Mark Manhole Covers manufactured to BS-EN 124-2 Compliant skid resistant for high risk location

 Anti-flex covers prevent the causes of cover seating wear, eliminating excessive noise and catastrophic failure.

 Specially designed cover support geometry reduces movement relative to the frame, minimising seating wear.

 Enlarged frame corners help to dissipate, load minimising bearing pressure.

 Indexed corners ensure correct orientation first time, every time.

 Inspection window allows safe and easy view into chamber.

600 X 600 X 80 RECESS TOP COVER & FRAME D 400							
S#	CLEAR OPENING AxA (MM)	OVER BASE BxB (MM)	TOTAL DEPTH H (MM)	RECESSED DEPTH R (MM)	LOAD CLASS	FEATURES	KITE MARK
1	600 X 600	740 x 740	100	80	D - 400	Double Seal/ GRP PROVISION	 YES

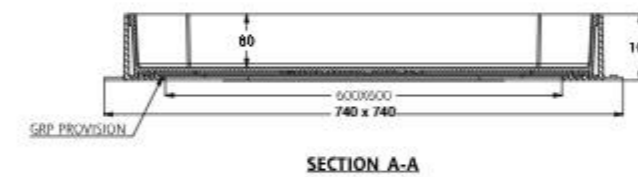
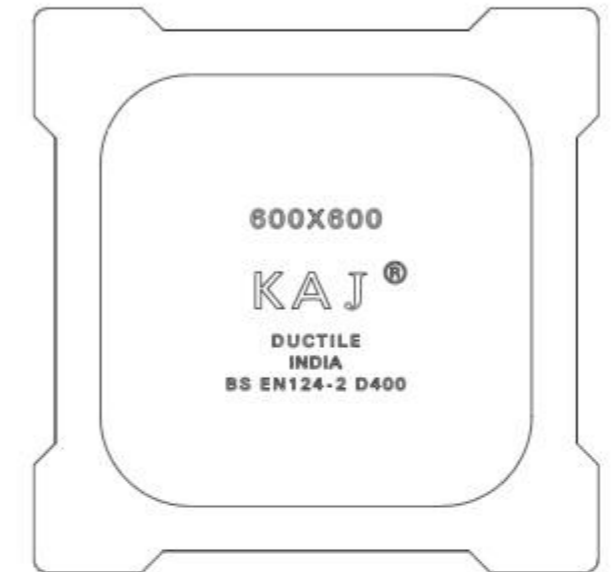
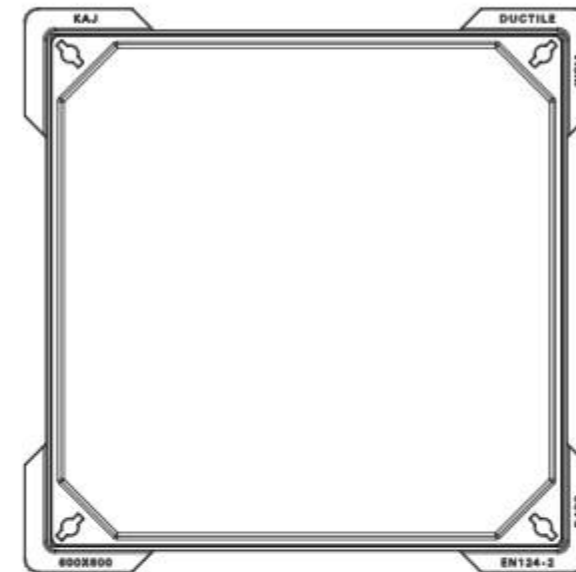

FEATURES:

1. In house, Load Test Pass Certificate shall be provided with all Kitemark products.
2. Manufactured as per BS EN 124 -2 Design Standard
3. Can also be designed with a concealed locking mechanism for safer access
4. Load achieve before concrete filling
5. Designed to non-rock
6. Can be provisioned for Gasket and GRP seating
7. Custom Marking/ Logos available on request

REV. NO	DATE	MODIFICATION	NAME	DATE	SIGN.	KAJ® KAJ BUILDING & CONSTRUCTION MATERIALS WHOLESALE TRADING LLC. Registered Office: Plot Number: 629-0 Building Name: ABBAY CENTER, Red Street - Dube Email: info@kajworld.com Website: www.kajworld.com Warehouse: MEDICAL AREA 17 - Malleswara Plot Number: 101, Government Land No.: 301, SHIMARA (KAJ)
			DRWN. BY:-	T.R.B	20.02.23	
			CHKD. BY:-	R.Mukherjee	20.02.23	
			APPRD. BY:-	T.R.B	20.02.23	COAT:- BLACK BITUMEN SHEET NO:- 1 OF 1 DRG. NO. KK-6012A
			MATERIAL:- DUCTILE IRON EN1563-500/7 TOLERANCE:- ISO 8062 (CT-11) BRAND:- KAJ			
			 LOAD:- D400 SCALE:- NTS			
ALL DIMENSIONS ARE IN MM.						

600X600X80 D400 GRATE MANHOLE COVER



D400 Kite Mark Manhole Covers manufactured to BS-EN 124-2 Compliant skid resistant for high risk location



Anti-flex covers prevent the causes of cover seating wear, eliminating excessive noise and catastrophic failure.



Specially designed cover support geometry reduces movement relative to the frame, minimising seating wear.



Enlarged frame corners help to dissipate, load minimising bearing pressure.



Indexed corners ensure correct orientation first time, every time.



Inspection window allows safe and easy view into chamber.

600X600 X80 D400 GULLY GRATE D 400						
S#	CLEAR OPENING AxA (MM)	OVER BASE BxB (MM)	TOTAL HEIGHT H (MM)	LOAD CLASS	FEATURES	KITE MARK
1	600 X 600	740 x 740	80	D - 400	Single Seal	YES

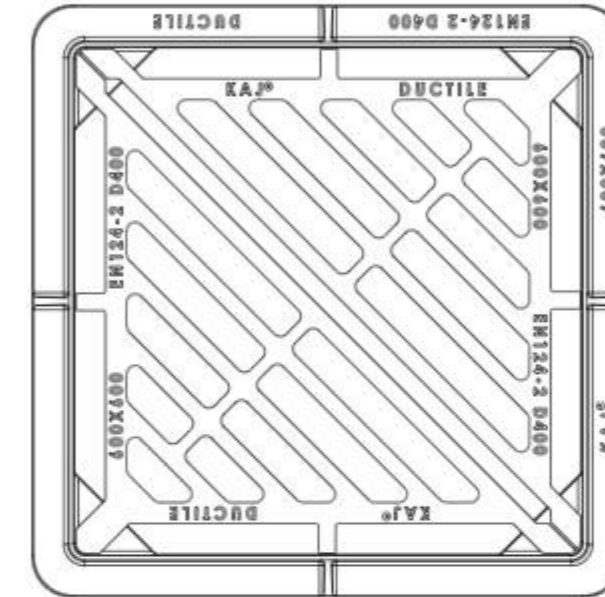

TOP VIEW

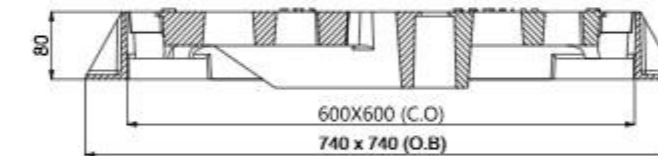

SECTION VIEW

FEATURES:

1. In house, Load Test Pass Certificate shall be provided with all Kitemark products.
2. Manufactured as per BS EN 124 -2 Design Standard
3. Can also be designed with a concealed locking mechanism for safer access
4. Load achieve before concrete filling
5. Designed to non-rock
6. Can be provisioned for Gasket and GRP seating
7. Custom Marking/ Logos available on request

DRWN. BY:-	T.R.B	20.02.23		KAJ® KAJ BUILDING & CONSTRUCTION MATERIALS WHOLESALE TRADING LLC. Registered Office: Plot Number: 125-0 Building Name: KAJA CENTER, Madhav - Dabas Email: info@kajworld.com / Website: www.kajworld.com Warehouse: INDENTRA AREA 17, Madhav Street Plot Number: 100, Government Land No.: 302, SHAMAD (B&L)
CHKD. BY:-	R.Mukherjee	20.02.23		
APPRD. BY:-	T.R.B	20.02.23		
MATERIAL:- DUCTILE IRON EN1563-500/7 TOLERANCE:- ISO 8062 (CT-11) BRAND:- KAJ				
ALL DIMENSIONS ARE IN MM.			LOAD:- D400 SCALE:- NTS	DRAWING DESCRIPTION:- 600X600 D 400 GULLY GRATE S/S COAT:- BLACK BITUMEN
REV. NO	DATE	MODIFICATION	SHEET NO:- 1 OF 1	
			DRG. NO. KK-6013A	

600X600X100 D400 SOLID TOP DOUBLE TRIANGLE WITH GRP PROVISION



D400 Kite Mark Manhole Covers manufactured to BS-EN 124-2 Compliant skid resistant for high risk location



Anti-flex covers prevent the causes of cover seating wear, eliminating excessive noise and catastrophic failure.



Specially designed cover support geometry reduces movement relative to the frame, minimising seating wear.



Enlarged frame corners help to dissipate, load minimising bearing pressure.



Indexed corners ensure correct orientation first time, every time.



Inspection window allows safe and easy view into chamber.

600X600X100 D400 SOLID TOP DOUBLE TRIANGLE						
S#	CLEAR OPENING AxA (MM)	OVER BASE BxB (MM)	TOTAL HEIGHT H (MM)	LOAD CLASS	FEATURES	KITE MARK
1	600 X 600	700 x 700	100	D - 400	Double Seal/ GRP PROVISION	YES

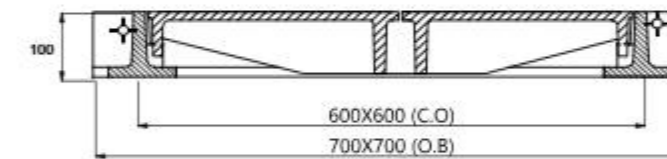
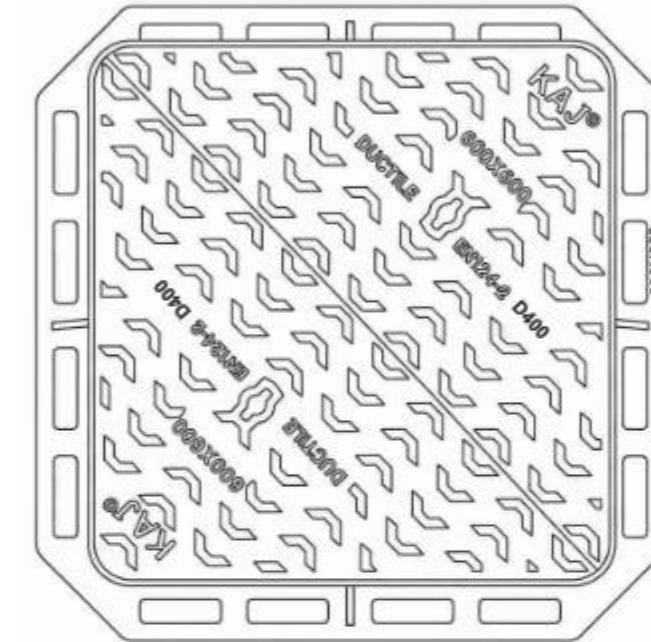

SECTION VIEW

FEATURES:

1. In house, Load Test Pass Certificate shall be provided with all Kitemark products.
2. Manufactured as per BS EN 124 -2 Design Standard
3. Can also be designed with a concealed locking mechanism for safer access
4. Load achieve before concrete filling
5. Designed to non-rock
6. Can be provisioned for Gasket and GRP seating
7. Custom Marking/ Logos available on request

DRWN. BY:-	T.R.B	20.02.23	SIGN.	KAJ® KAJ BUILDING & CONSTRUCTION MATERIALS WHOLESALE TRADING LLC. Registered Office: Plot Number - 129-D Building Name - ARBAU CENTER, Mad Street - Dabra Email: info@kajworld.com / Website: www.kajworld.com Warehouse: INDENTRA, AREA 17, Madhya Street Plot Number: 100, Government Land No.: 302, SHAMAD (BAE)
CHKD. BY:-	R.Mukherjee	20.02.23		
APPRD. BY:-	T.R.B	20.02.23		
MATERIAL:-	DUCTILE IRON EN1563-500/7			
TOLERANCE:-	ISO 8062 (CT-11)			DRAWING DESCRIPTION:- 600X600X100 D400 SOLID TOP DOUBLE TRIANGLE
BRAND:-	KAJ			
LOAD:-	D400		COAT:-	BLACK BITUMEN
SCALE:-	NTS		SHEET NO:-	1 OF 1
REV. NO	DATE	MODIFICATION	ALL DIMENSIONS ARE IN MM.	
			DRG. NO. KK-6014 A	

800 X 800 SERIES



800X800X100 D400 SOLID TOP MANHOLE COVER WITH GRP SEALING PROVISION

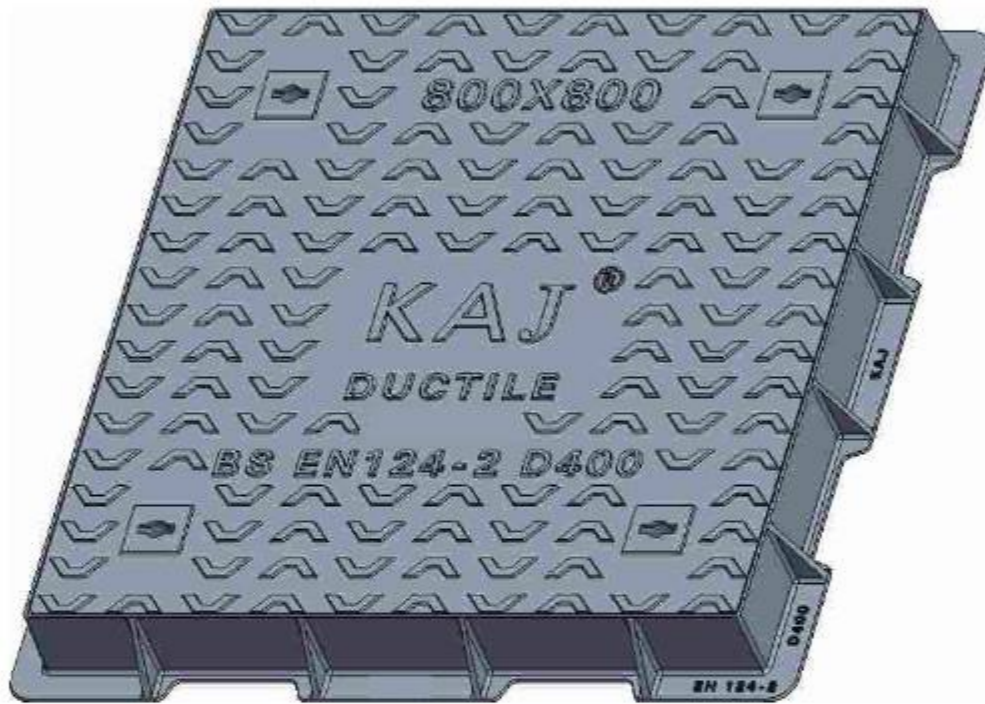

D400 Kite Mark Manhole Covers manufactured to BS-EN 124-2 Compliant skid resistant for high risk location



Anti-flex covers prevent the causes of cover seating wear, eliminating excessive noise and catastrophic failure.



Specially designed cover support geometry reduces movement relative to the frame, minimising seating wear.



Enlarged frame corners help to dissipate, load minimising bearing pressure.



Indexed corners ensure correct orientation first time, every time.



Inspection window allows safe and easy view into chamber.

800X800 X100 D 400 SOLID TOP COVER AND FRAME						
S#	CLEAR OPENING	OVER BASE	TOTAL HEIGHT	LOAD CLASS	FEATURES	KITE MARK
	AxA (MM)	BxB (MM)	H (MM)			
1	800 X 800	1050 x 1050	100	D- 400	Double Seal/ GRP PROVISION	YES

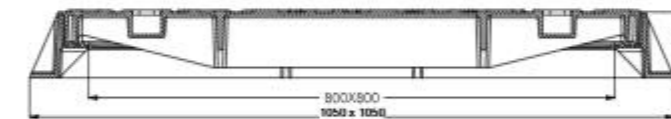
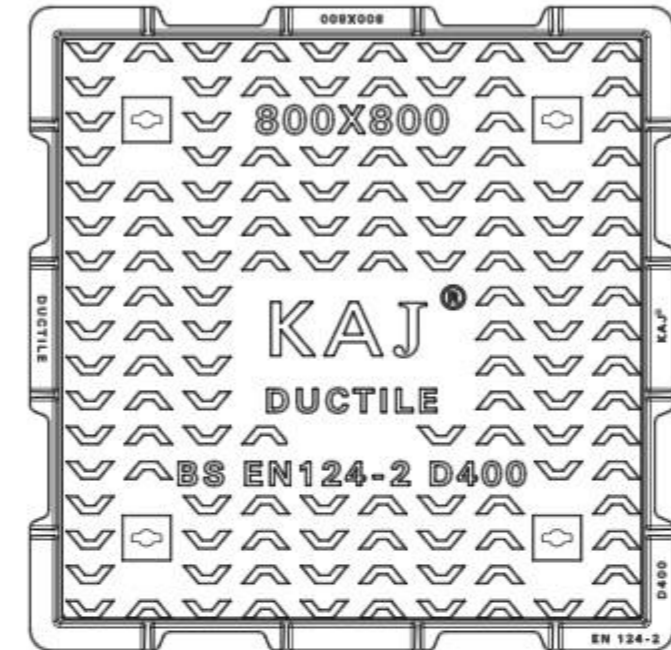

SECTION B-B

FEATURES:

1. In house, Load Test Pass Certificate shall be provided with all Kitemark products.
2. Manufactured as per BS EN 124 -2 Design Standard
3. Can also be designed with a concealed locking mechanism for safer access
4. Load achieve before concrete filling
5. Designed to non-rock
6. Can be provisioned for Gasket and GRP seating
7. Custom Marking/ Logos available on request

REV. NO	DATE	MODIFICATION	NAME	DATE	SIGN.
			DRWN. BY:-	T.R.B	20.02.23
			CHKD. BY:-	R.Mukherjee	20.02.23
			APPRD. BY:-	T.R.B	20.02.23
			MATERIAL:- DUCTILE IRON EN1563-500/7		
			TOLERANCE:- ISO 8062 (CT-11)		
			BRAND:- KAJ		
				LOAD:-	D400
				SCALE:-	NTS
			ALL DIMENSIONS ARE IN MM.		

KAJ® KAJ BUILDING & CONSTRUCTION MATERIALS WHOLESALE TRADING LLC.
 Registered Office: Plot Number: 019-0 Building Name: ABBAY CENTER, Red Street - Dabra
 Email: info@kajworld.com / Website: www.kajworld.com
 Warehouse: INDUSTRIAL AREA-17, Malviya Street
 Plot Number: 101, Government Land No.: 301, SHARAD (RAJ)

DRAWING DESCRIPTION:-
**800X800 SOLID TOP D400
 FRAME AND COVER (WITH GRP)**

COAT:- BLACK BITUMEN

SHEET NO:- 1 OF 1

DRG. NO. **KK-801 A**

800X800X80 D400 RECESS TOP MANHOLE COVER WITH GRP SEALING PROVISION



D400 Kite Mark Manhole Covers manufactured to BS-EN 124-2 Compliant skid resistant for high risk location



Anti-flex covers prevent the causes of cover seating wear, eliminating excessive noise and catastrophic failure.



Specially designed cover support geometry reduces movement relative to the frame, minimising seating wear.



Enlarged frame corners help to dissipate, load minimising bearing pressure.



Indexed corners ensure correct orientation first time, every time.



Inspection window allows safe and easy view into chamber.

800X800X80 RECESS TOP COVER & FRAME D 400

S#	CLEAR OPENING AxA (MM)	OVER BASE BxB (MM)	TOTAL DEPTH H (MM)	RECESSED DEPTH R (MM)	LOAD CLASS	FEATURES	KITE MARK
1	800 X 800	970 x 970	100	80	D - 400	Double Seal/ GRP PROVISION	YES

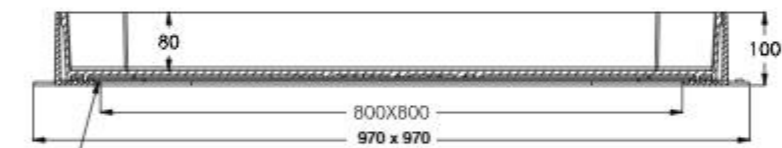
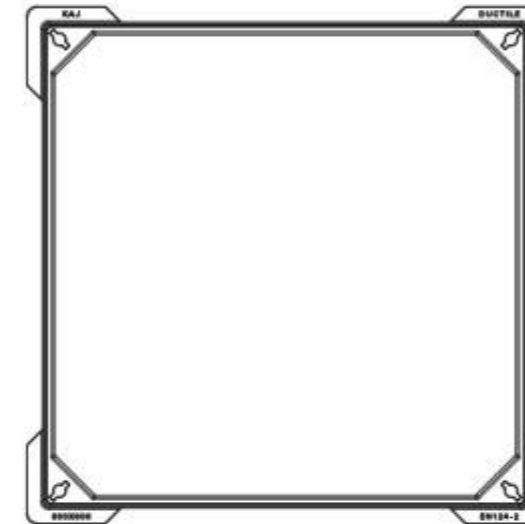

GRP PROVISION SECTION A-A

FEATURES:

1. In house, Load Test Pass Certificate shall be provided with all Kitemark products.
2. Manufactured as per BS EN 124 -2 Design Standard
3. Can also be designed with a concealed locking mechanism for safer access
4. Load achieve before concrete filling
5. Designed to non-rock
6. Can be provisioned for Gasket and GRP seating
7. Custom Marking/ Logos available on request

REV. NO	DATE	MODIFICATION	NAME	DATE	SIGN.	KAJ® KAJ BUILDING & CONSTRUCTION MATERIALS WHOLESALE TRADING LLC. Registered Office: Plot Number: 429-D Building Name: ABBU CENTER, Real Street - Dubai Email: info@kajworld.com Website: www.kajworld.com Warehouse: INDUSTRIAL AREA 17 - Mulla Street Plot Number: 101, Government Land No. - 815, SHARJAH (UAE)
			DRWN. BY:-	T.R.B	20.02.23	
			CHKD. BY:-	R.Mukherjee	20.02.23	
			APPRD. BY:-	T.R.B	20.02.23	
			MATERIAL:-	DUCTILE IRON EN1563-500/7		
			TOLERANCE:-	ISO 8062 (CT-11)		
			BRAND:-	KAJ		
				LOAD:-	D400	
				SCALE:-	NTS	
			ALL DIMENSIONS ARE IN MM.			

CHANEL GRATING SERIES

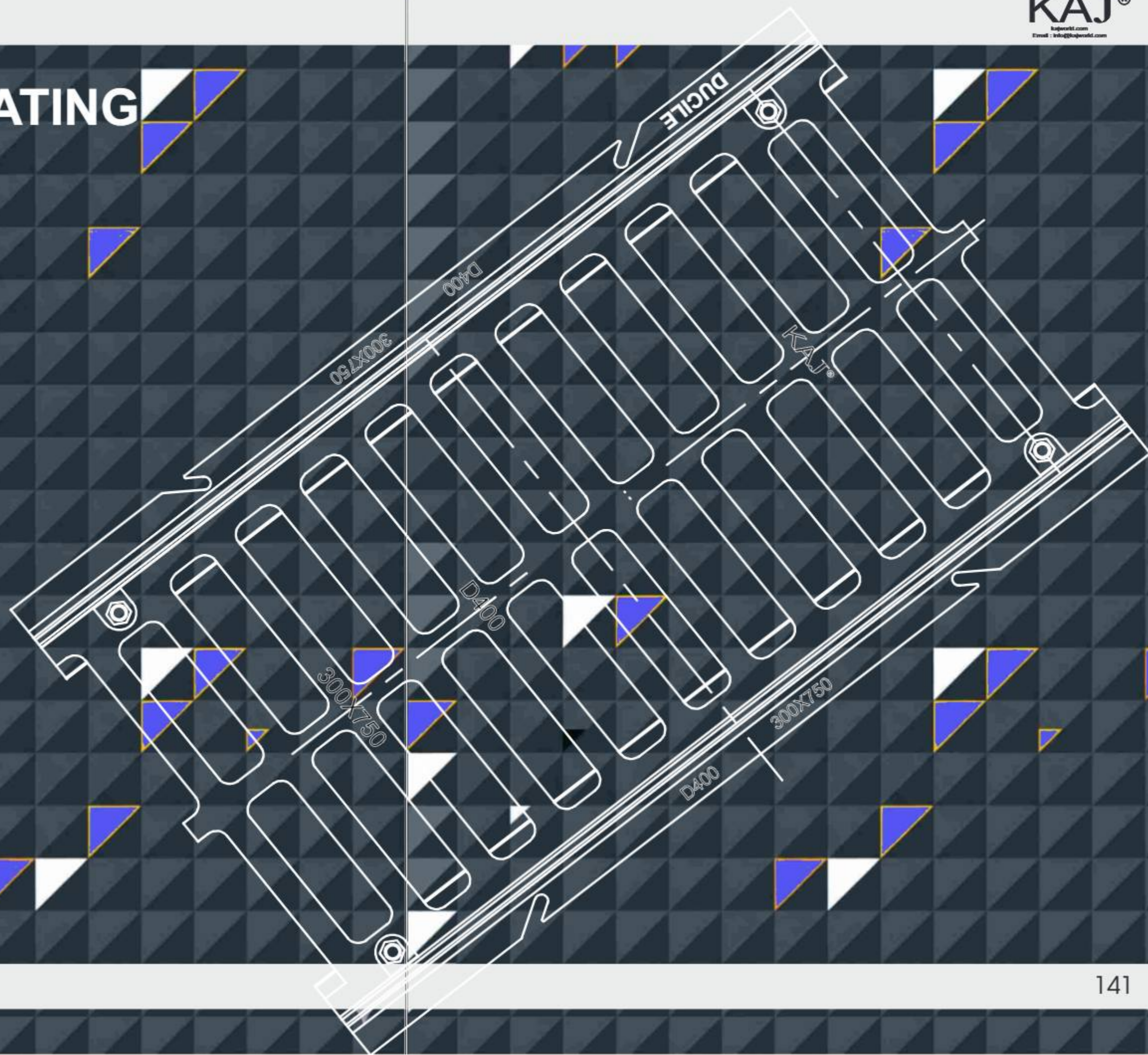

300X750X75 D400 CHANNEL GRATING MANHOLE COVER WITH GRP SEALING PROVISION

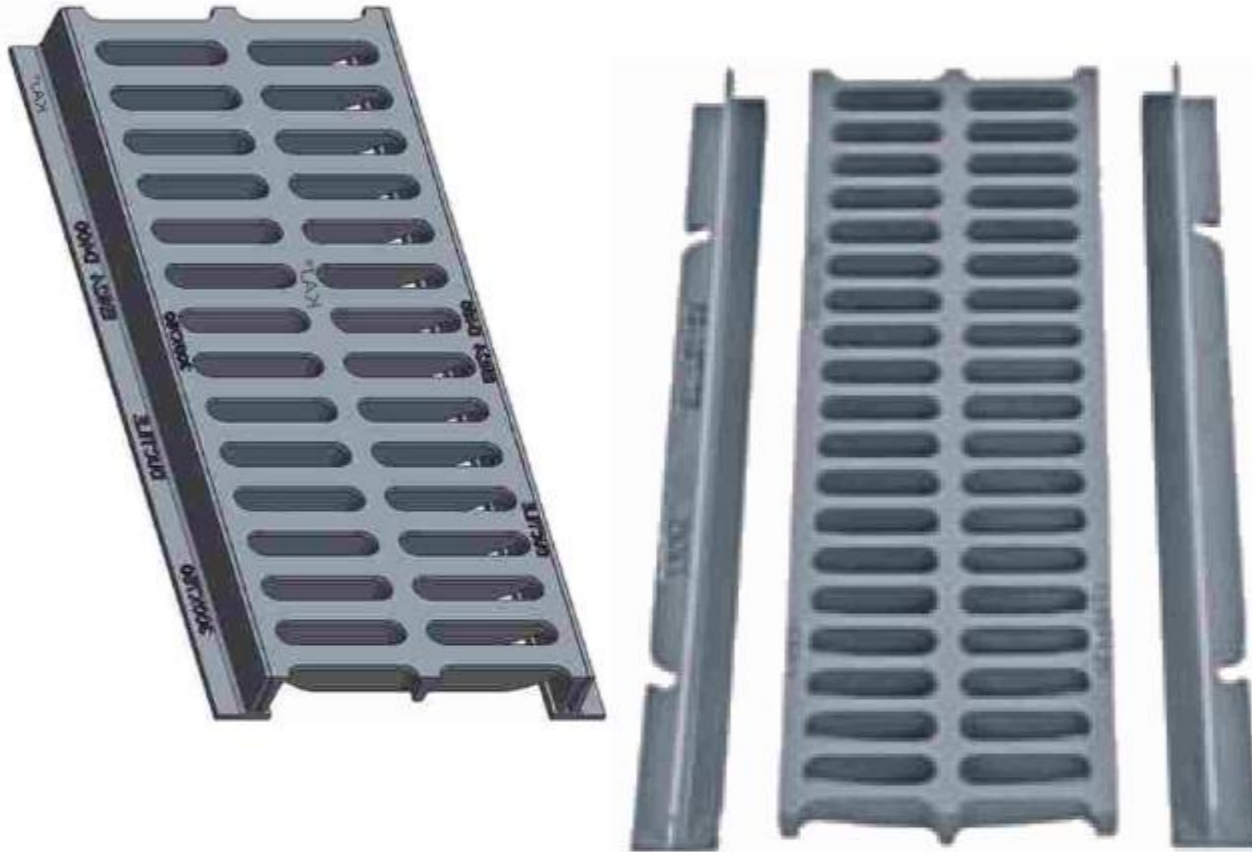

D400 Kite Mark Channel Grating manufactured to BS-EN 124-2 Compliant skid resistant for high risk location



Anti-flex covers prevent the causes of cover seating wear, eliminating excessive noise and catastrophic failure.



Specially designed cover support geometry reduces movement relative to the frame, minimising seating wear.



Enlarged frame corners help to dissipate, load minimising bearing pressure.



Indexed corners ensure correct orientation first time, every time.



Inspection window allows safe and easy view into chamber.

300X750X50 D400 CHANNEL GRATING

S#	CLEAR OPENING AxA (MM)	OVER BASE BxB (MM)	TOTAL HEIGHT H (MM)	LOAD CLASS	FEATURES	KITE MARK
1	300 X 750	300x 435	75	D- 400	Double Seal/ GRP PROVISION	YES

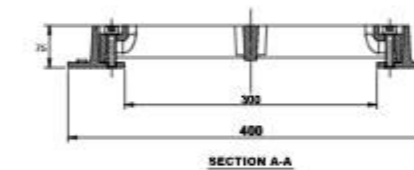
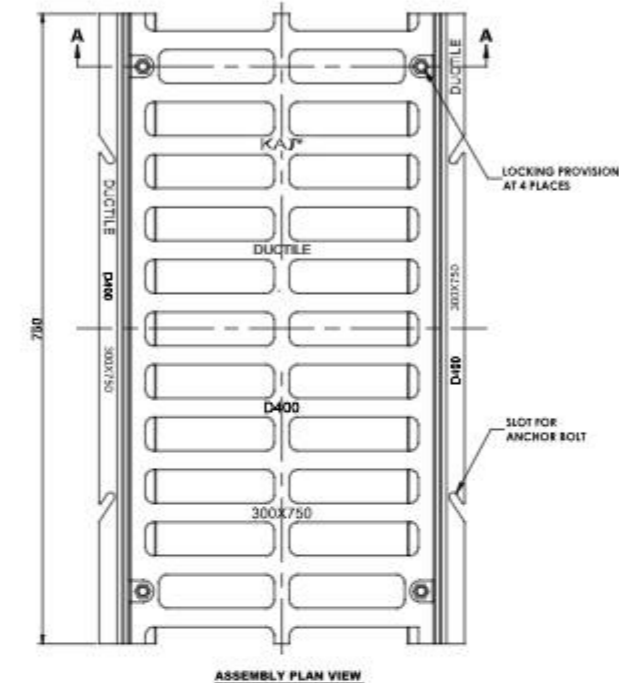

FEATURES:

1. In house, Load Test Pass Certificate shall be provided with all Kitemark products.
2. Manufactured as per BS EN 124 -2 Design Standard
3. Can also be designed with a concealed locking mechanism for safer access
4. Load achieve before concrete filling
5. Designed to non-rock
6. Can be provisioned for Gasket and GRP seating
7. Custom Marking/ Logos available on request

REV. NO	DATE	MODIFICATION	NAME	DATE	SIGN.
			DRWN. BY:- T.R.B	20.02.23	
			CHKD. BY:- R.Mukherjee	20.02.23	
			APPRD. BY:- T.R.B	20.02.23	
			MATERIAL:- DUCTILE IRON EN1563-500/7		
			TOLERANCE:- ISO 8062 (CT-11)		
			BRAND:- KAJ		
			LOAD:- D400		
			SCALE:- NTS		
			COAT:- BLACK BITUMEN		
			ALL DIMENSIONS ARE IN MM.		

KAJ® KAJ BUILDING & CONSTRUCTION MATERIALS WHOLESALE TRADING LLC.
 Registered Office: Plot Number: 615-3 Building Name: KAJBU CENTER, 1st Street - Dabra
 Email: info@kajworld.com / Website: www.kajworld.com
 Warehouse: IND/2846, AREA 17, Mohliu Street
 Plot Number: 101, Government Land No.: 301, SHAMAD (B&I)

DRAWING DESCRIPTION:-
300X750 CHANNEL GRATING D400

SHEET NO:- 1 OF 1
 DRG. NO. **KK- 750 A**

Range of products

With an aim contribution to the reduction of whole life costs associated with the installation, operation and maintenance of municipal castings, **KAJ Brand Building Material** offer a comprehensive range of products that are designed and engineered to include standard features to help improve durability, operator safety, asset security and overall performance.



Developed through a deep understanding of the markets we serve, our range of products focus on delivering tangible benefits to meet and exceed the needs of clients, specifiers, installers and operators.

Safety

The development of a comprehensive range of hinged access covers and gully grates that help minimise the risk of injury through static lifting of ironwork. Studies have demonstrated that by using hinged solutions the required lifting is reduced by up to 50%.

Security

Through the provision of flexible security solutions to act as a deterrent against theft, unauthorized access or vandalism. Security locking can be provided by the use of standard feature such as a spring bar, or captive hinge, factory fitted security bolts and screws or by providing the facility to enable a locking kit to be fitted retrospectively.

Durability

Research lead by IIT Rourke University into ironwork interacts with the road construction, determined that critical features such as the seating contact areas, the thickness of the frame and flanges and controlled manufacturing tolerances when designed, engineered and manufactured correctly combine to ensure and enhance optimum performance.

Kaj Building Material has used the results of this research to develop the Load Transfer System (LTS). This system has become a standard feature across our core ranges giving peace of mind that products are stronger, more resilient and even more durable. Products when installed using high performance resin based bedding mortars, LTS has been proven to reduce the dynamic loads subjected to the casting and the underlying structure and bedding by 50% increasing the life of the installation thus avoiding the need for frequent reinstatement.



European Standard Section 1 Access Covers

F900 E600 GripTop D400 C250 B125



UK range



UK-range

Features

- Non-rock design
- Automatic cover security locking
- Semi-ergonomic hinging design
- LTS installation and durability features
- HA 104/09 compliant
- Sewers for Adoption 7 compliant

Options

- Badging options
- Available as GripTop Heaviest Cover Section.
- ▲ Use loop handled lifting keys.

BS EN 124 loading class	Clear opening A x B (mm)	Over base C x D (mm)	Depth E (mm)	Cover mass (kg)	Total mass (kg)
D400	600 x 600	806 x 806	101	27.3/20.7	82
D400	600 x 600	806 x 806	151	35.5/26.2	92
D400	676 x 675	880 x 830	101	27.3/20.7	98
D400	675 x 675	880 x 830	151	35.5/26.2	109

Opt-Emax range

The KAJ® UK range has been specifically developed to offer quicker, easier and safer access to underground services. Opt-Emax hinged covers offer many benefits over traditional lift-out covers, without compromising performance - thanks to the LTS feature within the design of the frame.

The KAJ® UK range is ergonomically positive and offers all the benefits associated with the E+ feature.



Opening



STEP 1 - halves of cover lift separately in sequence as marked.



STEP 2 - each cover opens to 100° for maximum access.



STEP 3 - cover is securely held at 90° to prevent accidental closing. Cover cannot be closed unless correct procedure is followed.

For products that have the KAJ UK feature the trademark is detailed in the 'At a glance' section of the product pages.



Commitment Commitment to Quality

Committed to offering products of the highest quality and performance. As a basis for this objective the company is committed to operating strict manufacturing and quality systems. It also recognises the responsibility of the companies' workforce in meeting these quality objectives and seeks to continually improve their awareness, training and development needs.

The BSI is the worlds most recognisable 3rd party product certification mark. The majority of the products within this guide are certified by Indian / Eropean/ UAE Standards and bear the Kaj logo, giving reassurance that the product is in full compliance with the requirements of the standard under which it is designed, manufactured, tested and inspected. This internationally respected symbol of product quality accredits the following standards relevant to access covers, gratings, channel gratings and surface boxes manufactured in India.

IS EN 124

Gully tops and manhole tops for vehicular and pedestrian areas.

IS 5834 Pt 2 2011

Specification for small surface boxes.

ISO 9001: 2015

ISO 9001 is the most widely used international standard that provides and effective framework for an effective Quality Management System. The quality systems that govern the manufacture of the products featured in this guide are in accordance with the requirements of BS EN ISO 9000: 2008 Registration Number FM12908.

BSI Verify

The BSI Verify scheme was developed to assist companies in the selection and pre-qualification of suppliers and certifies a companies' level of performance against key criteria such as Health & Safety, Environmental controls & procedures and Quality. KAJ® Building Material has achieved category A status.

CE Marking

The proposed revision of EN 124 includes a requirement for CE marking as it is anticipated that once published it will become a harmonised standard which is in accordance with the Construction Products Regulations.

Kaj Brand Mark

The KAJ® Brand Mark attests to the compliance of products and services with the relevant standards, and is enhanced with additional specifications, to match the market's expectations as closely as possible.



Access Covers

E600/F900



LTS
FEATURE

F900
CLASS

>70
PSRV

6
GROUP

APPLICATION

Features

- Double triangular
- Non-rock design
- Frame lifting points
- LTS installation and durability features

Options

- Badging
- Security locking

Recommended for use in areas that are subjected to very heavy wheel loads such as aircraft pavements, container ports and dockside.

* Cover mass per pair.

BS EN 124 loading class	Clear opening A x B (mm)	Over base C x D (mm)	Depth E (mm)	Cover mass (kg)	Total mass (kg)
F900	602 x 602	802 x 802	150	86*	141
F900	678 x 678	878 x 878	150	99*	159
F900	1223 x 1223	1423 x 1423	150	110*	295
F900	1842 x 690	2042 x 890	150	110*	445



LTS
FEATURE

E600
CLASS

>70
PSRV

5
GROUP

APPLICATION

Features

- Double triangular
- Non-rock design
- Frame lifting points
- LTS installation and durability features
- HA 104/09 compliant
- Sewers for Adoption 7 compliant

Options

- Badging Options

Recommended for use in trunk roads carrying fast-moving traffic and industrial areas subject to exceptionally heavy traffic eg. dual carriageways, docks and container areas.

* Cover mass per pair.
Use loop handled lifting keys.

BS EN 124 loading class	Clear opening A x B (mm)	Over base C x D (mm)	Depth E (mm)	Cover mass (kg)	Total mass (kg)
E600	610 x 610	815 x 815	150	78*	127
E600	610 x 610	815 x 815	150	78*	129

KAJ UK RANGE

Features

- Single-piece cover
- Double seal

BS EN 124 loading class	Clear opening A x B (mm)	Over base C x D (mm)	Depth E (mm)	Cover mass (kg)	Total mass (kg)
C250	603 x 603	804 x 804	76	86	125.5

Options

- Security locking option
- Badging options

Recommended for use inside industrial buildings where a double sealed unit is essential to meet building regulations.

Use loop handled lifting keys.



Features

- Single-piece cover
- Slide-out cover design
- Single seal

BS EN 124 loading class	Clear opening A x B (mm)	Over base C x D (mm)	Depth E (mm)	Cover mass (kg)	Total mass (kg)
B125	602 x 452	752 x 602	75	33	53
B125	600 x 600	752 x 752	75	41	63
B125	902 x 902	1068 x 768	75	59	89

Options

- Security locking option
- Badging options
- Ventilated options

Medium duty, cover and frame in ductile iron.

Use loop handled lifting keys.



RECESS DOUBLE SEAL

Features

- 75mm recessed single-piece cover
- Single seal
- Four corner lifting points

BS EN 124 loading class	Clear opening A x B (mm)	Over base C x D (mm)	Depth E (mm)	Cover mass (kg)	Total mass (kg)
B125	450 x 450	558 x 558	100	27	49
B125	600 x 600	711 x 711	100	38	68

Recommended for use domestic applications eg. driveways, patio areas and featuring recessed cover for infill.

Use loop handled lifting key.



KAJ UK RANGE

Access Covers

D400



Inter-Ax D400-N Sealed

Options

- Seal plate options
- Badging options

Features

- Double triangular
- Non-rock design
- Push-fit seal plate compatible frame design
- LTS installation and durability features

BS EN 124 loading class	Clear opening A x B (mm)	Over base C x D (mm)	Depth E (mm)	Cover mass (kg)	Total mass (kg)
D400	600 dia	802 x 802	100	50*	85
D400	600 x 600	817 x 768	100	58*	93
D400	757 x 608	960 x 820	100	75*	111
D400	757 x 608	960 x 820	100	75*	111

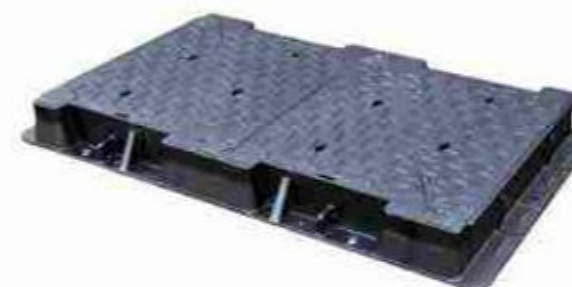

Recommended for use in city roads carrying heavy traffic.

* Cover mass per pair
AG - complete with MSG bolt down seal plate (0.5 bar pressure)
- recommended that frame is bolted to chamber.
For BeD6 I or Be38 I, if sealed product is required, seal plate must be ordered separately Hm125 D (187079) Hm124 D (187078) respectively.

Use loop handled lifting keys.



Silent Knight

Features

- Double triangular
- Non-rock design
- HA 104/09 compliant
- Sewers for Adoption 7 compliant

Options

- Badging options
- Security locking option
- Safety grid options available

Code with safety grid	SAP Code safety grids	Code with sec. screws	SAP Code sec. screws	grid & sec. screws & sec. screws	SAP code safety grid & sec. screws	BS EN 124 Loading class	Clear opening A x B (mm)	Over base C x D (mm)	Depth E (mm)	Cover mass (kg)	Total mass (kg)
CJ14 1/AP	186073	CJ14 1/BL	TBA	CJ14 1/BN	TBA	D400N	1210 x 685	1375 x 850	100	72*	207
CJ24 1/AP	TBA	CJ24 1/BL	186080	CJ24 1/BN	TBA	D400N	1825 x 685	1985 x 850	100	72*	306
CJ16 1/AP	186075	CJ16 1/BL	186076	CJ16 1/BN	TBA	D400N	1210 x 685	1375 x 850	150	72*	238
CJ26 1/AP	186083	CJ26 1/BL	186085	CJ26 1/BN	186084	D400N	1825 x 685.5	1985 x 848.5	150	72*	350
CJ34 1/AP	186087	CJ34 1/BL	208888	CJ34 1/BN	TBA	D400N	1210 x 685	1375 x 850	100	72*	209
CJ44 1/AP	TBA	CJ44 1/BL	186098	CJ44 1/BN	TBA	D400N	1825 x 685	1985 x 850	100	72*	308
CJ36 1/AP	186092	CJ36 1/BL	186093	CJ36 1/BN	TBA	D400N	1210 x 685	1375 x 850	150	72*	239
CJ46 1/AP	186101	CJ46 1/BL	TBA	CJ46 1/BN	TBA	D400N	1825 x 685.5	1985 x 848.5	150	72*	351

Recommended for use in city carrying heavy traffic.

* Cover mass per pair.
Use loop handled lifting keys.

Grip Top range

On UAE roads today there are many factors which can contribute to increasing the risk of skidding to two and four wheel vehicles. One of these factors is access covers which have been worn and polished over decades of being trafficked, that when also wet can increase the risk of skidding.

A strategy established by the Department of Transport is to create a safe infrastructure as a means to improve road safety, key elements include:

A recognition that good engineering and design reduces the risk

A focus on proactive or planned maintenance of national roads

At Megacity we recognise our role in contributing to road safety and the importance in providing durable long term solutions.

Through an exhaustive new product development programme we have been able to achieve a major breakthrough that has resulted in the development of GripTop. Fully compliant and kitemarked with the requirements of IS EN 124 GripTop features a patented factory applied maintenance free top surface which brings together high performance bonding agents and bauxite aggregate on a recessed ductile Iron Substrate.

In partnership with UAE City, large scale testing has been carried out across the city center at regular intervals over a 5 year period. Located around the inner ring road which is subjected to continuous heavy traffic a selection of installations were independently tested to determine any degradation in the skid resistance. The results have proven the long term performance of GripTop with a industry leading PSRV (Polished Skid Resistance Value) of >75 on average.

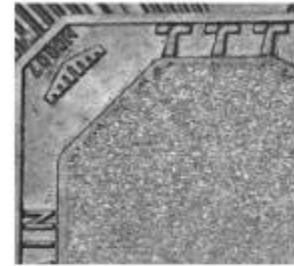

For products that have the LTS feature, the trademark is detailed in the 'At a glance' section of the product pages.

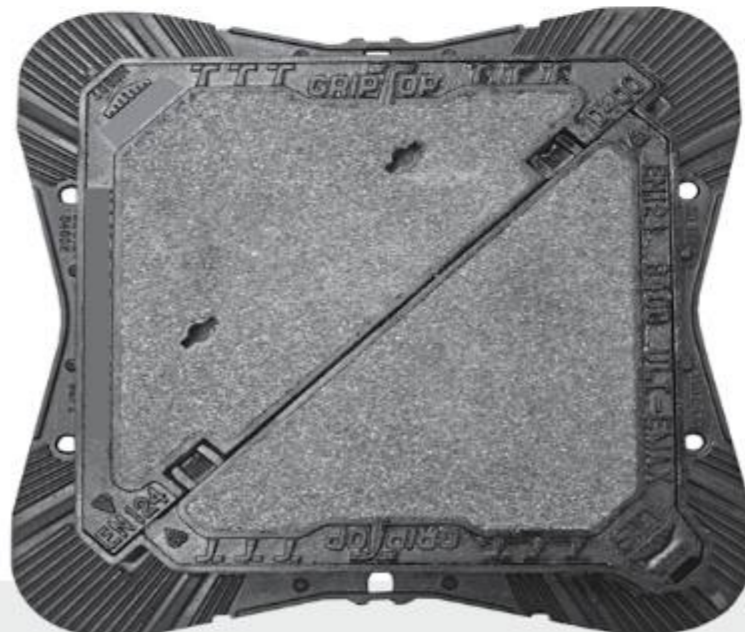

KAJ UK RANGE

Access Covers

B125



Features

- Single-piece cover
- Single or double seal

Options

- Security locking option

Recommended for use in areas where vehicular trafficking is not expected and where a single or double seal is required.

Use I handled lifting keys.

Ductile Light Duty

BS EN 124 loading class	Clear opening A x B (mm)	Over base C x D (mm)	Depth E (mm)	Cover mass (kg)	Total mass (kg)
Single Seal					
D400	600 dia	802 x 802	100	50*	85
D400	600 x 600	817 x 768	100	58*	93
Double Seal					
D400	757 x 608	960 x 820	100	75*	111
D400	757 x 608	960 x 820	100	75*	111



Features

- 30mm recessed single-piece cover
- Single or double seal

Options

- Security locking option

Recommended for use in domestic applications eg. driveways, patio areas and featuring recessed cover for infill.

Use T handled lifting keys.

Ductile Light Duty Recessed

BS EN 124 loading class	Clear opening A x B (mm)	Over base C x D (mm)	Depth E (mm)	Cover mass (kg)	Total mass (kg)
B125	600 x 450	711 x 559	70	30	50
B 125	608 x 608	711 x 711	69	32	54
B125	607 x 455	776 x 624	72	39	65
B125	606 x 606	776 x 776	72	52	82

KAJ UK RANGE

Gully Grates



Section 2 Gully Grates

F900 F600 D400 C250 B125

High Performance Gratings

Growth in traffic speed and intensity coupled with ever changing climate condition is placing greater emphasis on the importance of installing high performance problem free, durable drainage solutions. This has led to Kaj Building Material developing a range of gratings that include standard features that when combined aid the reduction of future maintenance or replacement costs.

Designed with the needs of the client and operator in mind the Megacity Vantage and Megacity Max gratings combines high efficiency with the additional functional benefits of operator safety and asset security.



KAJ UK RANGE

Gully Grates



For products that have the E+ feature, the trademark is detailed in the 'At a glance' section of the product pages.

Increased safety
 • Captive hinge with integral hinge pins



Increased safety
 • Grating lever points



Increased security
 • Automatic spring arm locking device



Improved durability
 • Wedge seating arrangement



Increased security
 • Retro fit locking device option



Increased security
 • Automatic spring arm locking device



Improved efficiency
 • Highly efficient grating design

KAJ UK RANGE

Gully Grates

D400

Watershed

The Watershed gully grate has been developed to meet the needs of engineers and the rigors of today's traffic loadings.

Watershed offers ease of maintenance with its pricing slot for quick opening and hinged action.

Watershed combines the benefits of both double triangular and hinged grates in one unit. Thanks to its wedge seating, Watershed provides non-rock performance and the captive hinge allows fast and easy access.

Large wedge seatings
Give the Watershed enhanced stability and long-term performance in the most arduous traffic conditions.

Captive hinge
For easy access with added security.

Single-piece unit
Hinged for easy access.

Pricing slot
For easy opening.

Large water area
Watershed has a large water area to help clear surface water quickly from roads.

Manufacturing from ductile iron, the Watershed utilizes the wedge seat principal.

The Watershed wedge seating operates in two directions to ensure the security and location of the grate within the frame.



Wedge seat principle



Features

- Captive hinged grating
- Non-rock design
- Single-piece grating

Options

Security locking option
Recommended for use in city roads carrying continuous heavy traffic, with the addition of captive hinge for ease of maintenance.

Watershed

Description	BS EN 124 loading class	Clear Opening A x B (mm)	Over base C x D (mm)	Depth E (mm)	Water way area (cm²)	HA102 reference	Total mass (kg)
Kerb Hinging	D400	371 x 371	585 x 525	100	980	R	38
Kerb Hinging	D400	473 x 431	625 x 575	100	980	R	48
Left hand opening	D400	373 x 433	575 x 525	100	1090	R	35
Right hand opening	D400	373 x 433	575 x 525	100	1090	R	35
Left hand opening	D400	370 x 310	525 x 400	100	810	S	28
Left hand opening	D400	510 x 380	684 x 454	100	1225	R	40.4
Left hand opening	D400	600 x 450	750 x 540	100	1850	Q	53
Right hand opening	D400	600 x 450	750 x 540	100	1850	Q	53
Left hand opening	D400	600 x 450	750 x 540	100	1850	Q	53

KAJ UK RANGE

Access Covers

C250/B125



Features

- Single-piece cover
- Double seal

Options

- Security locking option
- Badging options

Recommended for use inside industrial buildings where a double sealed unit is essential to meet building regulations.

Use loop handled lifting keys.

BS EN 124 loading class	Clear opening A x B (mm)	Over base C x D (mm)	Depth E (mm)	Cover mass (kg)	Total mass (kg)
C250	603 x 603	804 x 804	76	86	125.5



Features

- Single-piece cover
- Slide-out cover design
- Single seal

Options

- Security locking option
- Badging options
- Ventilated options

Medium duty, cover and frame in ductile iron.

Use loop handled lifting keys.

BS EN 124 loading class	Clear opening A x B (mm)	Over base C x D (mm)	Depth E (mm)	Cover mass (kg)	Total mass (kg)
B125	602 x 452	752 x 602	75	33	53
B125	602 x 620	752 x 752	41	41	63
B125	902 x 602	1068 x 768	59	59	89

KAJ UK RANGE

Gully Grates

D400



Features

- Captive hinged grating
- Non-rock design
- Single-piece grating
- LTS installation and durability features
- Automatic grating security locking
- Wedge seating security locking
- Wedge seating
- HA 102 & 104/09 compliant
- Sewers for Adoption 7 compliant

Options

Additional security locking option
Recommended for use in city roads carrying continuous heavy traffic where efficient water removal is required – with the addition of a captive hinge for ease of maintenance.

Units fitted with Installation Plus Leveling System

Megacity-Max

BS EN 124 loading class	Clear opening A x B (mm)	Over base C x D (mm)	Depth E (mm)	Waterway area (cm ²)	Ha102 reference	Total mass (kg)
D400	450 x 450	660 x 550	100	1240	R	48
D400	450 x 450	625 x 550	150	1240	R	53
D400	450 x 450	625 x 550	100	1220	R	42
D400	450 x 450	625 x 550	100	1220	R	42
D400	450 x 450	625 x 550	150	1220	R	50.6
D400	450 x 450	625 x 550	150	1220	R	50.6



Features

- Captive hinged grating
- Non-rock design
- Single-piece grating
- Automatic grating security locking
- Wedge seating
- HA 102 & 104/09 compliant

Options

- Additional security locking option
Recommended for use in carriageway surface water drainage channels with a 1:5 V shaped profile.

Aqua Vantage

BS EN 124 loading class	Clear opening A x B (mm)	Over base C x D (mm)	Depth E (mm)	Waterway area (cm ²)	Ha102 reference	Total mass (kg)
D400	450 x 450	660 x 550	100	1240	R	48
D400	450 x 450	625 x 550	150	1240	R	53
D400	450 x 450	625 x 550	100	1220	R	42
D400	450 x 450	625 x 550	100	1220	R	42

KAJ UK RANGE

Gully Grates

D400



Features

- Double triangular grating
- Non-rock design
- LTS Installation and durability features



BS EN 124 loading class	Clear opening A x B (mm)	Over base C x D (mm)	Depth E (mm)	Waterway	Ha102	Grating	Total mass (kg)
D400	435 x 435	587 x 587	100	1200	Q	25°	43

* Grating mass per pair

Recommended for use in trunk and city roads carrying continuous heavy traffic and in areas prone to excessive traffic clipping.



Waterway 2000

Features

- Double triangular grating
- Non-rock design
- Large waterway area
- LTS Installation and durability features

Options

Three or four flanged option
Large water area provides efficient water removal in areas subject to high water run-off eg. catchpits, motorway verges, between verges and valleys, cuttings etc.

BS EN 124 loading class	Clear opening A x B (mm)	Over base C x D (mm)	Depth E (mm)	Waterway area (cm ²)	Ha102 reference	Grating mass (kg)	Total mass (kg)
D400	607 x 607	802 x 802	100	2000	-	57*	86
D400	607 x 607	802 x 720	100	2000	P	57*	84
D400	600 x 600	705 x 820	150	2000	P	57	96
D400	600 Dia	802 x 802	100	2000	-	57	90
D400	607 x 607	820 x 820	150	2000	-	57*	96



Features

- Large waterway area
- Non-rock design
- LTS durability feature
- Multiple double triangular design

Waterway 2400

BS EN 124 loading class	Clear opening A x B (mm)	Over base C x D (mm)	Depth E (mm)	Waterway	Ha102	Total mass (kg)
D400	425 x 415 (x2)	1036 x 525	101	2400	P	84

Recommended for use in areas subjected to high water run-off including catchpits, motorway verges, cutting and between verges and valleys.

Channel Gratings

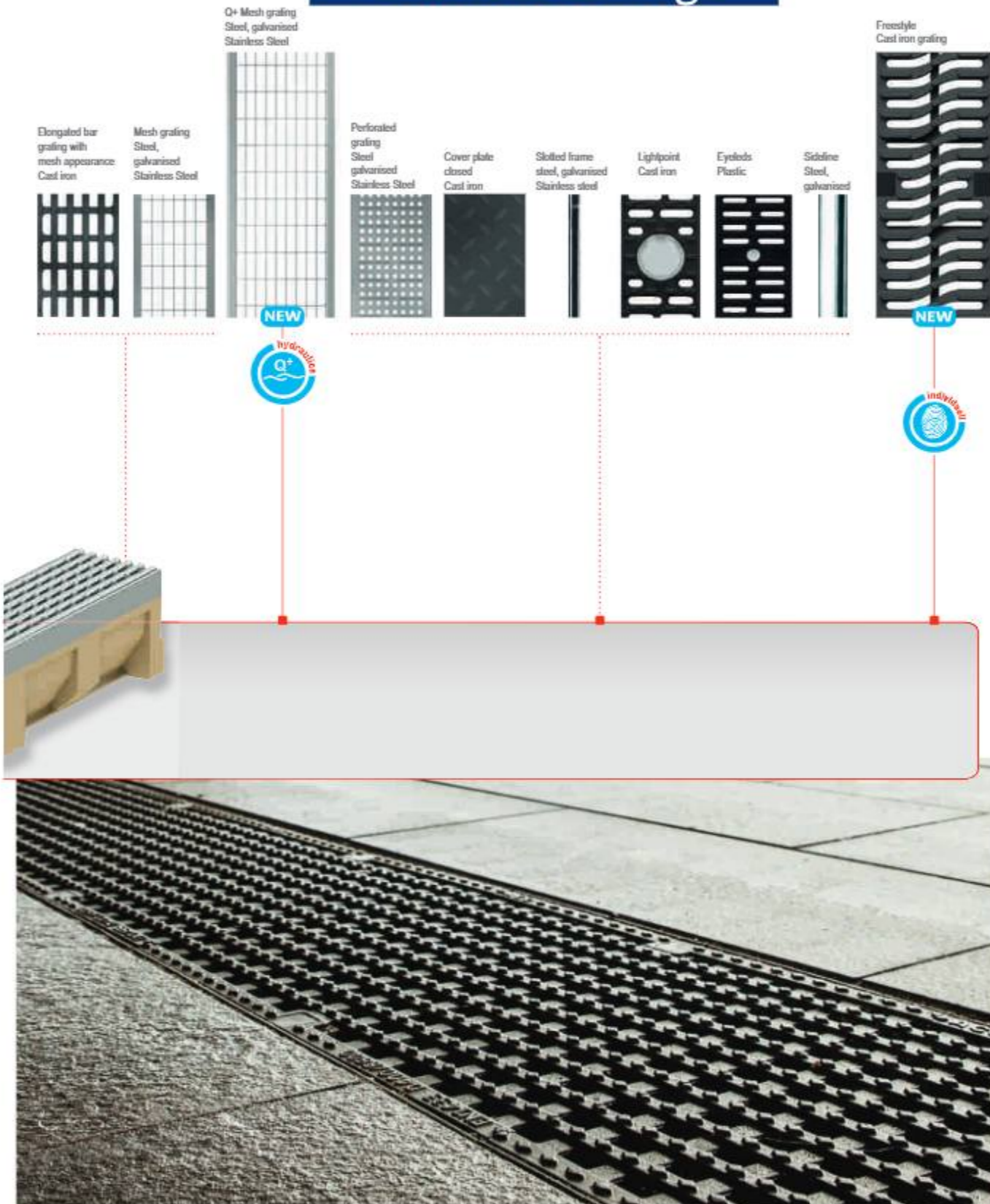

Channel Gratings

Elongated and diagonal bar grating

The simple elongated bar gratings, available in galvanised steel or stainless steel, and the diagonal bar grating made of stainless steel fit unobtrusively into all floor coverings. An elongated cast iron bar grating is available with a rustic mesh appearance.

Cast iron EN-GJS,
 nominal widths 100, 150, 200, 300
 and 400 mm,
 load classes C 250, D 400 and E 600
 optionally steel, galvanised/stainless steel,
 nominal width 100 mm,
 load class A 15
 diagonal bar grating stainless steel,
 nominal width 100 mm,
 load class B 125
 according to DIN EN 1433/DIN 19580
 with Drainlock screwiest stop.



Elongated bar grating
Cast iron



Elongated bar grating
Galvanized steel and stainless
steel



Diagonal bar
grating
Galvanized steel



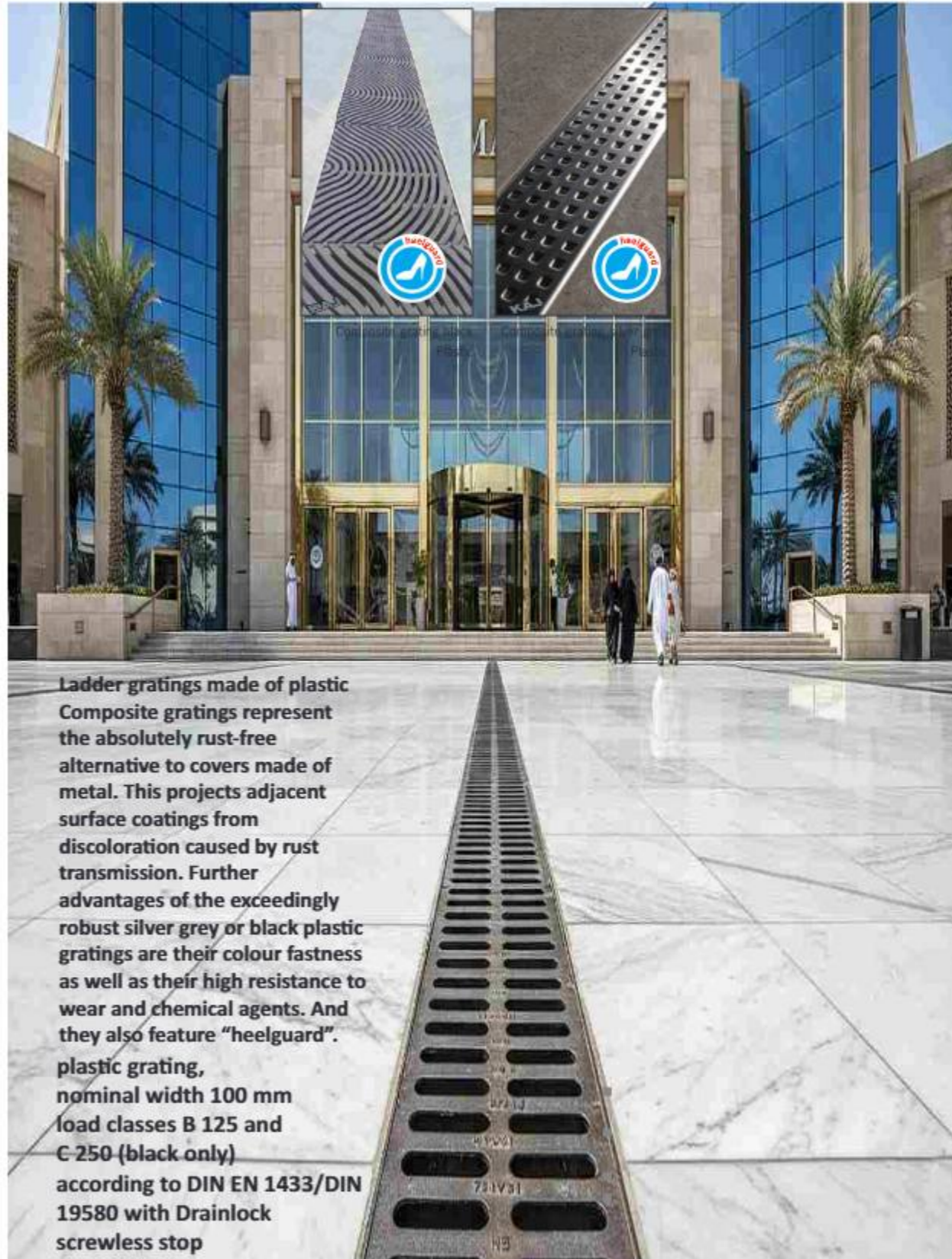

Ladder gratings made of plastic Composite gratings represent the absolutely rust-free alternative to covers made of metal. This projects adjacent surface coatings from discoloration caused by rust transmission. Further advantages of the exceedingly robust silver grey or black plastic gratings are their colour fastness as well as their high resistance to wear and chemical agents. And they also feature "heelguard". plastic grating, nominal width 100 mm load classes B 125 and C 250 (black only) according to DIN EN 1433/DIN 19580 with Drainlock screwless stop



Mounting the LED elements in the slotted frame



Sideline Stainless steel



Sideline

Drainage channels disguised as narrow slots guarantee clean clean lines on squares and pathways, in gardens and parks. Slotted frame drainage now has a new design dimension: it holds new lighting effects. The Megacity Sideline shows a well thought-out symbiosis of drainage and LED technology.

Besides the effective design, an important advantage is the improved feeling of safety achieved through the combination of slotted frame drainage and LED technology. The linear light tracks also underscore the character of modern architecture.

A user-friendly control unit allows solutions ranging from small applications to complex integration in all building automation systems. The energy-efficient IP 67 LED lamps are highly resistant and maintenance-free.

Versions in the lengths of 1,000 and 500 mm are available. In the RGB version, a 6 m light line can be connected to one power supply.

Maintenance for the drainage channel is effected using service components. Inspection elements allow easy cleaning and fast access to the cables. With the help of the 100 mm high slotted frame, paving stones can be accurately aligned with the slots.

- made of stainless steel,
- nominal width 100 mm
- LED light colour: monochrome or RGB (All colours, mixed colours, colour gradations, colour changes; dynamic lighting scenes are also possible.)
- load class C 250 according to DIN EN 1433/DIN 19580



Practical example

- 5 Light points on a 2.5 m channel
- Components required:
- 1 x basic set, 3 x extensions
- 2 x channels 100 cm
- 1 x channel 50 cm
- 5 x Light point cast iron gratings
- 2 x universal closing end caps

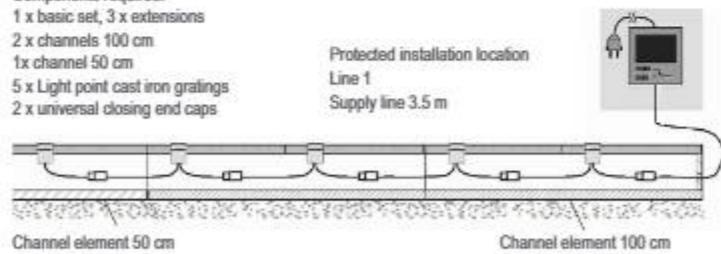

Ladder gratings

Ladder gratings by Megacity with slot widths of up to 10mm protect your heels. You have the choice between gratings in galvanised steel, stainless steel and cast iron. The "Heelguard" ladder grating made of cast iron, with a slot width of only 5 mm, even offers high heels a stylish and safe footing at all times. This makes it ideal for public areas in cities.

Ladder grating steel, galvanised/stainless steel, nominal width 100 mm,
 load classes A 15 and C 250
 "Heelguard" ladder grating, cast iron EN-GJS, load class C 250
 ladder grating, cast iron EN-GJS, nominal widths 100, 150, 200, 300, 400 and 500 mm,
 load classes B 125, C 250 and D 400 according to DIN EN 1433/DIN 19580 with Dranlock screwless stop.



Ladder grating
Steel, galvanised



Ladder grating
Stainless Steel



"Heelguard" ladder grating
Cast Iron
Slot width only 5 mm



Ladder grating
Cast Iron





Longitudinal bar grating



With the new longitudinal bar grating made off high-quality stainless steel, Megacity is emphasising design. This grating is particularly suitable for installation in front of glass facades. Thanks to its free intake area, it quickly drains off any surface water. A slot width of only 6 mm makes the grating especially anti slip – an elegant solution for line drainage on facades and also at the interface between the facade and the open area.

- grating made of stainless steel, nominal width 100 mm
- load class B 125
- according to DIN EN 1433/DIN 19580
- with Drainlock screwless stop
- pickle passivated and grinded surface



Longitudinal profile grating



The longitudinal profile grating meets the highest safety requirements and thus sets new standards in line drainage: it has been awarded the "heel-guard" seal and with slot widths of 8 mm is anti-slip. In addition, this grating, which is available in galvanised steel and stainless steel, has a slip-proof structure. The free intake area guarantees fast drainage, and the continuous U-shaped profile also ensure clear visual lines. As an additional design option, this grating can be electro-polished on demand.

- optionally steel, galvanised / stainless steel nominal width 100 mm
- nominal width 100 mm
- load class B 125
- according to DIN EN 1433/DIN 19580
- with Drainlock screwless stop
- pickle passivated and grinded surface



Cast iron



KAJ cast iron – quality for all standards

The types of cast iron used by Kaj Guss in Kaiserslautern and Aarbergen are adapted to the continuously increasing requirements through intensive innovation and development processes: Both cast iron with lamellar graphite (grey cast iron GJL) and cast iron with nodular graphite (spheroidal cast iron sowers due to their high corrosion resistance. Guss offers the optimum solution for the respective application, independent of the material.

Steel/stainless



Kaj steel/ stainless steel – sophisticated components

The processing of both steel and stainless steel is a core expertise of **KAJ** in the different production facilities of the **KAJ** Group worldwide. Large investment sums ensure that our production facilities are always state-of-the-art. The high qualification of our skilled workers ensure high-quality products. Our own in-house plants for surface protection and finishing are used, among other things, in the production of **KAJ** Drainlock gratings.

Ductile Iron



KAJ plastic – innovative and flexible

Components made of plastic offer the greatest possible design freedom with regard to form and function. We use this potential to avoid expensive material combination and time-consuming jointing processes and to develop intelligent solutions "cast in one piece" to take their place. The plastic used by **KAJ** are characterised not only by their high breaking stresses (crushing strength) but also by their outstanding resistance to environmental influences. Simple machining options and low weight are the reasons for the outstanding user-friendliness of our plastic solutions.

Concrete



Kaj concrete – durable and reliable

Concrete is a material that plays a decisive role in tank construction for separator and drainage technology. Kaj tanks for drainage technology are made from a highly waterproof concrete, have a very high resistance and stability. The tanks can be used as separators, pumping stations, accident (spillage) systems or special chambers and can also be equipped with a plastic coating or lining. Kaj tanks made of concrete are a durable solution for the drainage and treatment of water.

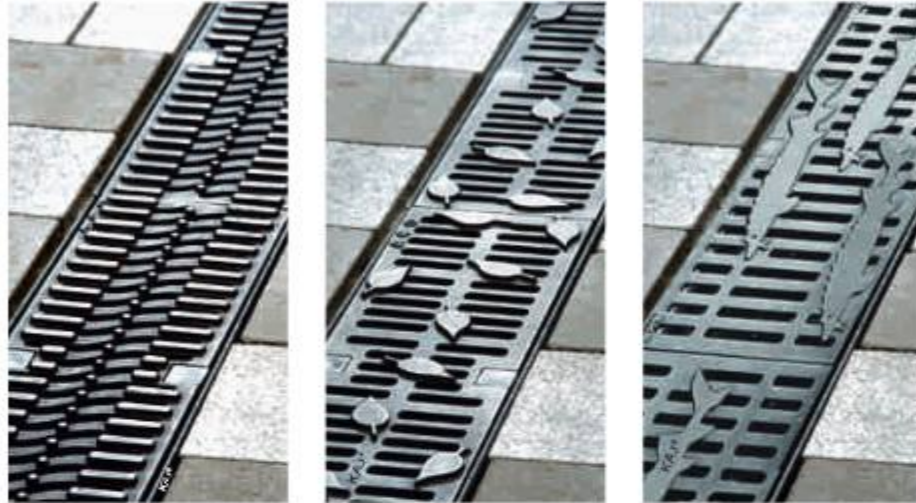

KAJ Freestyle cast iron gratings designed according to customer's wishes: Kaj Freestyle Flag, Kaj Free style Leaf, KAJ - Freestyle Sturgeon



KAJ Freestyle with lighting using Eyelets



KAJ MANHOLE COVERS: CITY TOP, CLASSIC TOP AND MULTI TOP ROUND COVER

The Kaj manhole top program with Kaj City Top, Classic Top and Multi Top



For tomorrow's infrastructure –

Operational safety, durability and cost efficiency are the main criteria defined for high traffic infrastructure. With the **KAJ** range of manhole covers, top sections and inlet gratings, **KAJ** satisfies all specifications pursuant to DIN EN 124/E DIN 1229. Intelligent product features such as lightweight covers and gratings, bottles locks, damping frame inserts, and hydraulic, optically attractive and technically sophisticated surface designs, underpin the **KAJ** Manhole product line's high engineering standards.

Typical applications

- roads, paths, piazzas
- airports and ports
- control shafts

Benefits

- durability and reliability
- high securing level and long lifetime
- user-friendly and safe in operation

Cover features

- Classic top is secured by highest mass per unit area
- City Top and Multi Top are secured by screwless and maintenance free locking devices.
- two anti-theft devices can be installed to prevent theft of City Top

Frame features

- a cushioning insert is placed in the frame of all Kaj manhole tops
- Bituplan frames offer highest load transfer to protect mortar bedding and shaft top
- a mobile entry-facility tool is firmly fixed in Multitop Lift or Bituplan frames



maintenance-free, bottleless, traffic-proof lock made of heavy-duty wear-and-tear resistant plastic in accordance with EN 124

A Plus for tomorrow's infrastructure – Kaj manhole cover Multitop Plus

A dramatic increase in goods traffic is expected in the next few years. Roads remain the number one mode of transport. Kaj has adapted the Multitop Plus manhole cover to the increasing market requirements. We have retained the tried and tested weight, handling, wear and mortar joint solutions and focused on the new product advantages: Quiet. Air permeable. Slip resistant.

- Quiest by means of safe damping inserts and by mechanically machined, extremely flat bearing surfaces on the cover and frame.
- Permeable through 323 cm² ventilation cross sections for better ventilation of the sewer.
- Slip resistant through a special surface profile on the cover and frame at least R11 according to DIN 51130.



ROUND MANHOLE COVER

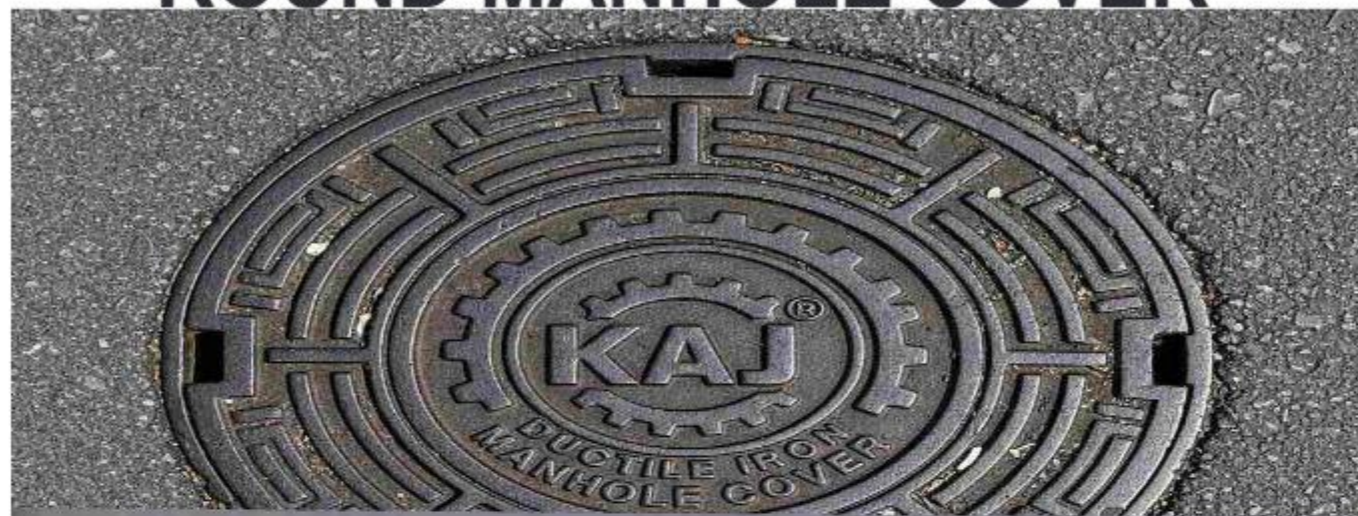

Ürün Kodu / Product Code
0225306

Ürün Kodu / Product Code
0225307

Ürün Kodu / Product Code
0225310

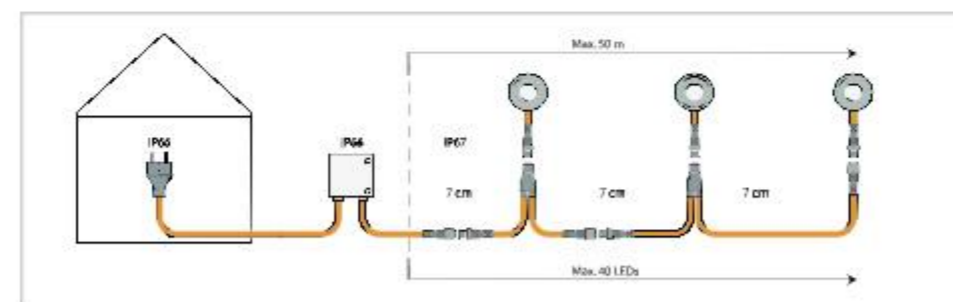
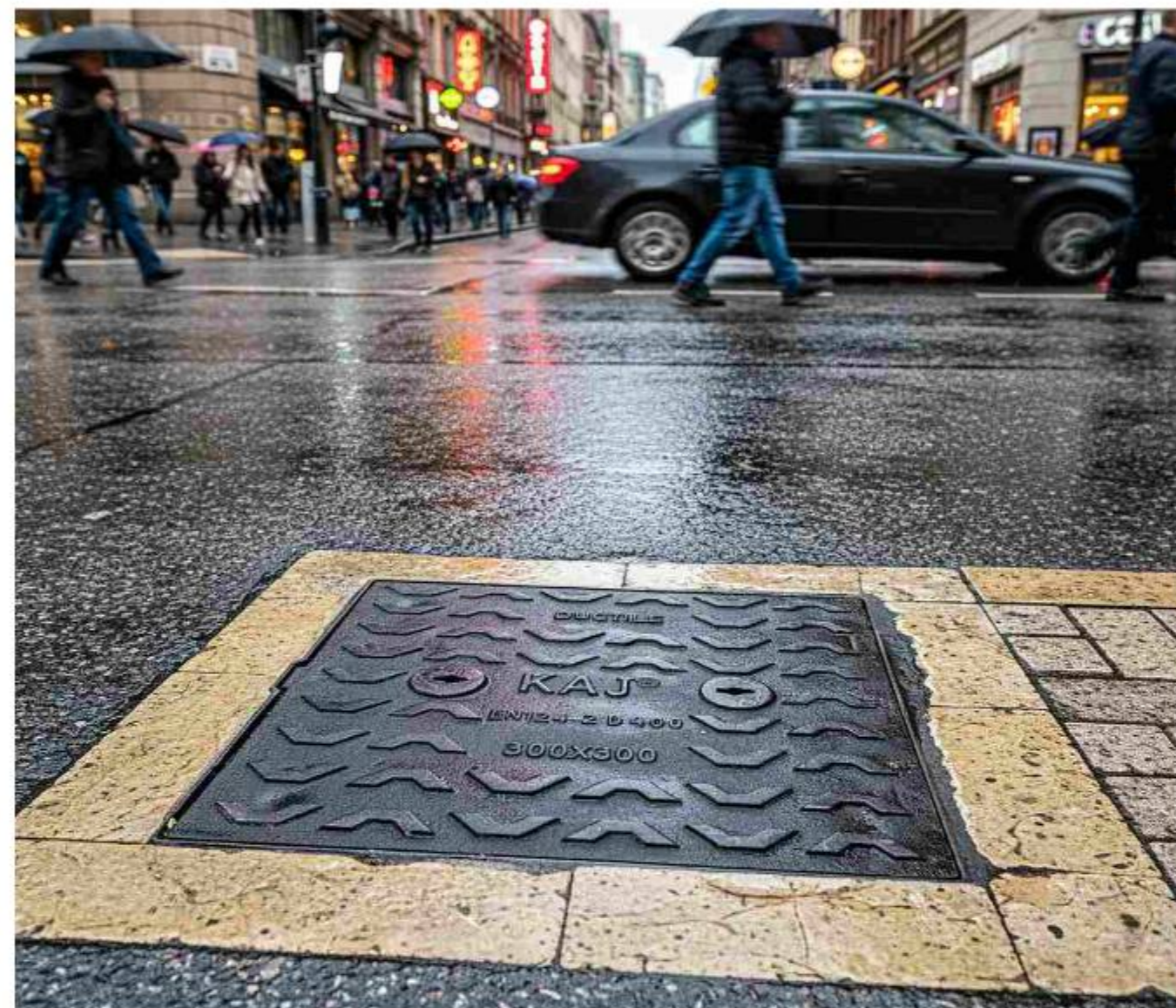
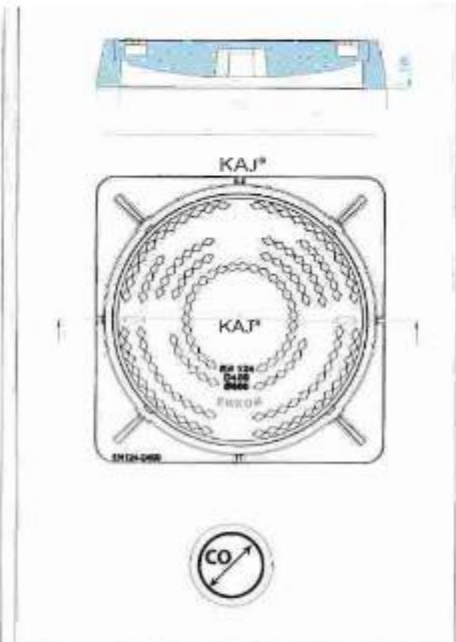
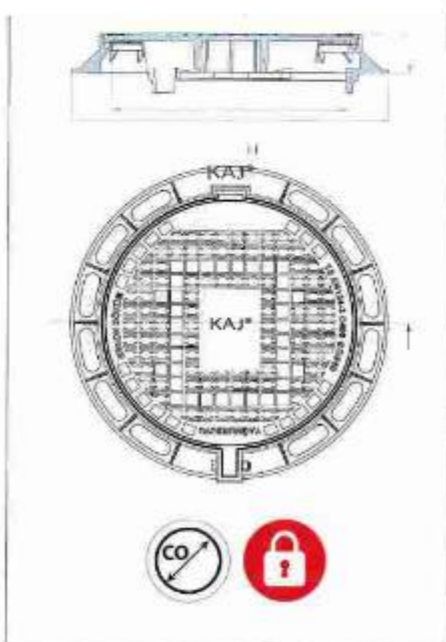

Practical example
5 KAJ lightpoints on a 2.5 m channel
Components required:
2 x channels 100 cm
1 x channel 50 cm
5 x plastic gratings with Eyelet
1 x transformer
4 x splitters 30/30
2 x universal closing end caps



Stability under the highest loads

Load resistance

The high strength of this heavy duty channel system is based on many details:

- Reinforcing ribs increase side wall strength and optimise load distribution
- Special anchoring feet provide perfect stability in the concrete surround
- Integrated anti-shunt lugs to prevent longitudinal grating movement, and low center of gravity provided safety even during installation
- An abutting edge rail for paviors of 10 cm height avoids unnecessary seams
- Smooth lateral walls are free of any protrusions, permitting easy abutment of surface coverings such as pav-iro, asphalt or concrete
- Powerlock boltless locking replaces bolts for easier assembly and maintenance

Award winning design

The product was awarded a German product (recognition) award for its excellent combination of form and function. A great design with many beneficial features:

- High load resistance
- High inflow profile
- Longitudinal bars preventing water by-pass
- Powerlock boltless locking
- Anti-shunt lugs to prevent longitudinal grate movement
- High quality coating to prevent corrosion
- Grate installation independent of channel direction

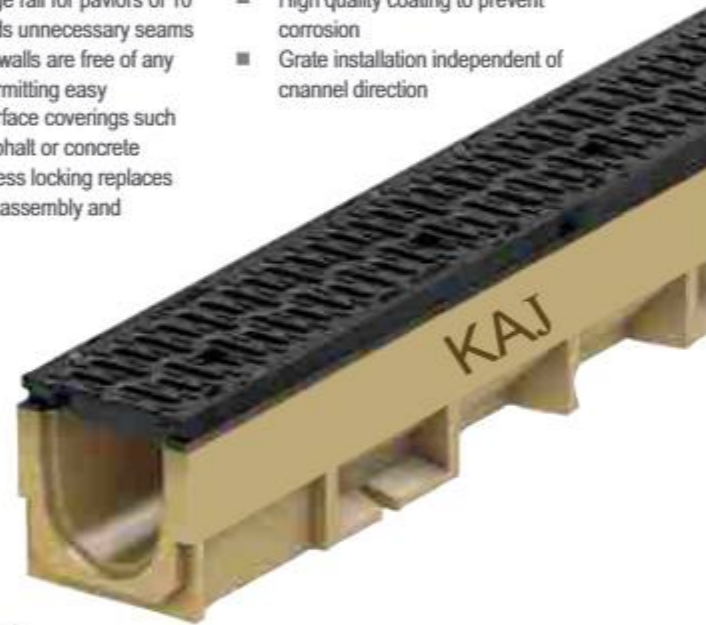

S 100 K channel
 Appearance and functionality optimised by a new grating design



Slim, quiet and extremely efficient

Slim solutions are not just good looking: the combination of crucial product properties make the Kaj Powerdrain a real professional all-round solution in polymer concrete. Its compelling features include unusually good hydraulic specifications, extremely high safety, and outstanding stability right up to the toughest heavy duty class F. All of these product benefits are founded on four main properties:

- reduced nominal widths
- innovative V-channel profile
- rugged sidewall construction
- integrated damping

The nominal widths differ from traditional widths: the Powerdrain was developed with internal widths of 75, 125, 175, and 275 mm. The design retains the hydraulically highly effective V-profile – an innovation launched by Kaj for line drainage solutions – and is made of high-strength polymer concrete. This not only makes the new slim Powerdrain systems extremely tough, they also have efficiencies comparable to the previously

standard 100, 150, 200 and 300 channels. The special elastomer damping between the grating and the channel, combined with the safely locked but still flexibly bedded grating, means permanent noise damping when vehicles drive over the channel.



Kaj DRAIN Power Drain
 v 75/100 P to 275/300 P



◀ **slim** : V-profile for high hydraulic performance



quite : the special elastomer damping means permanent noise damping



efficient : the boltless lock and tried-and-tested installation aids boost safety and efficiency at the construction site

Highlights from the A15 – E600 range of gratings

Longitudinal bar grating
 Stainless steel



Mesh grating Q*
 Galvanised steel
 Stainless steel



Composite grating with microgrip
 Anti-slip plastic



Slotted grating
 Galvanised steel
 Stainless steel
 Ductile iron



Cross bar grating
 Stainless steel



Perforated grating
 Galvanised steel
 Stainless steel



Composite grating Heelguard
 Ductile iron



Composite grating
 Ductile iron



optimised intake area



slot width max. 10 mm



according to DIN 51130, min. R 11

WASTE WATER TREATMENT SERVICE



SLUDGE TREATMENT

Different products like DAF, FBFR or SBR produce sludge with a high remaining water content. Sludge treatment systems like presses, big-packs or clarifiers process the sludge.



PRE - TREATMENT

Depending on the type of wastewater, we offer different pre-treatment systems like screens, filters, or clarifiers. Pre treatment ensures a long lifetime of the wastewater treatment plant.



CONTAINERIZED SYSTEMS

A containerized mobile wastewater treatment plant is a packaged wastewater treatment system where all wastewater treatment equipment is completely preinstalled in ISO shipping containers.



DIOX

Electrical Oxidation with diamondcoated electrodes. A highly efficient oxidation process to treat hard polluted wastewater and persistent substances like heavy metals. Mostly used for industrial wastewater treatment.



SSR

Sequential Batch Reactor. A robust biological wastewater treatment system. Mostly used for sewage treatment and as a pre-treatment step for industrial wastewater treatment.



FBFR

Fixed Bed Biological Reactor. High rate biological wastewater treatment system with a cascaded fixed bed module. Mostly used for municipal and industrial wastewater treatment.



QUICKONE

The ClearFox® QuickOne is a small domestic wastewater treatment system using the SBR technology. It treats wastewater between 4 and 50 PE.



NATURE

The ClearFox® Nature is a non-electric domestic wastewater treatment plant. It treats wastewater from 4 to 50 PE.



LEASING SOLUTIONS

We offer most of our solutions as leasing systems. Our services include delivery, commissioning and instruction of the operating personnel as well as dismantling of the system.



DAF

Dissolved Air Flotation. Separation of suspended solids like fat, oil and grease. Mostly used for Food & Beverage, CE & Gas, Plastic Recycling and Pharmaceutical wastewater treatment.

Stainless Steel Manhole Cover

Installation Effect

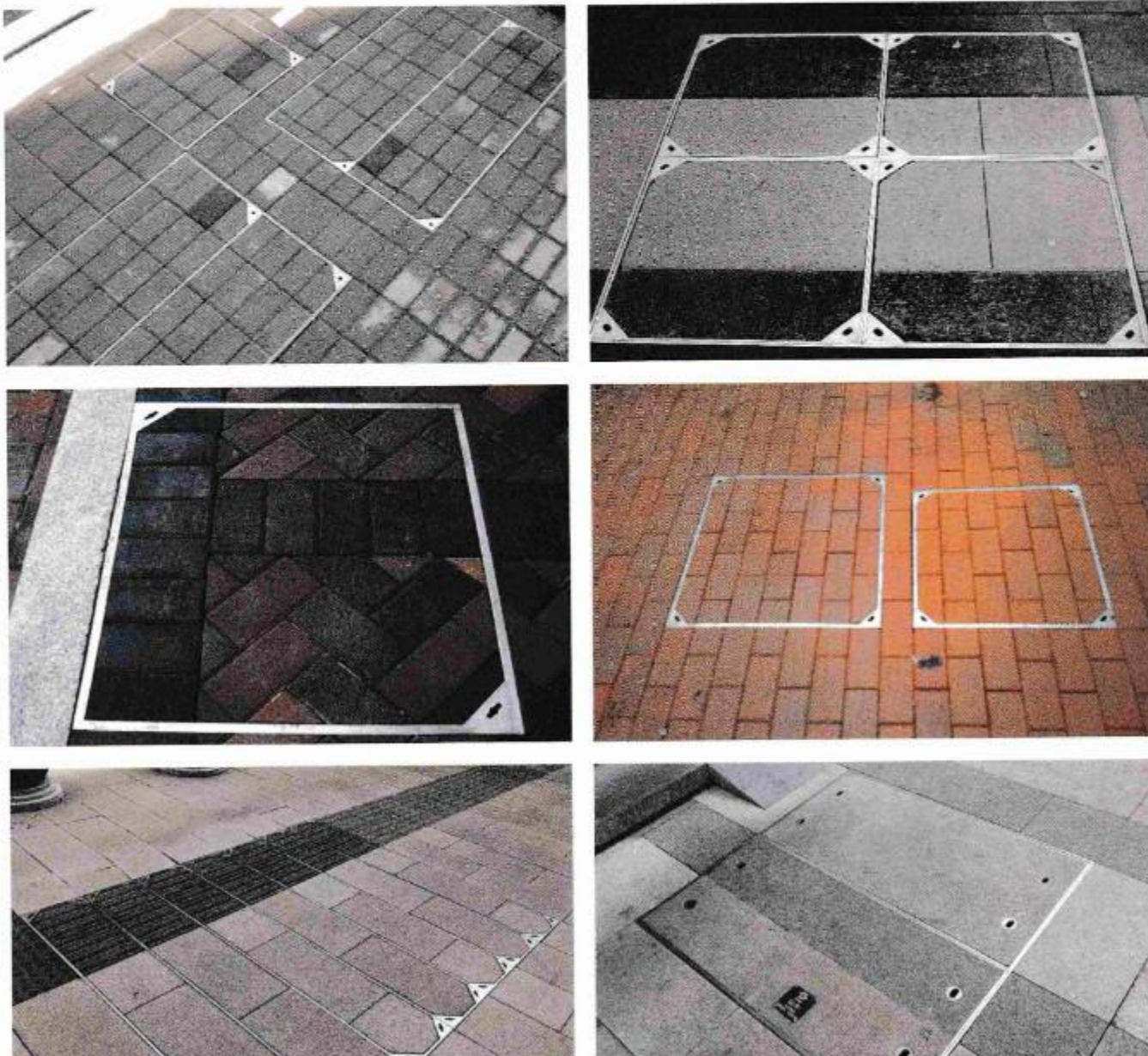

MANUFACTURING & SUPPLY PRODUCTS RANGE

KAJ®
PPR / PEXb SYSTEM

KAJ PPR and PEXb are installed in the...
products have been tested and approved for use in...
residential and commercial applications.

KAJ®
KAJ ROOF DRAIN & FLOOR DRAIN

KAJ® is a series of grates and gaskets...
KAJ® is a series of SS finished...
KAJ® is a series of SS finished...
KAJ® is a series of SS finished...

KAJ®
GALA

KAJ GALA is a series of...
KAJ GALA is a series of...
KAJ GALA is a series of...

KAJ®
KAJ DRAINAGE SYSTEM

Our drainage systems are...
KAJ® is a series of...
KAJ® is a series of...
KAJ® is a series of...

Stainless Steel Manhole Cover

Various Styles Can Be Customized

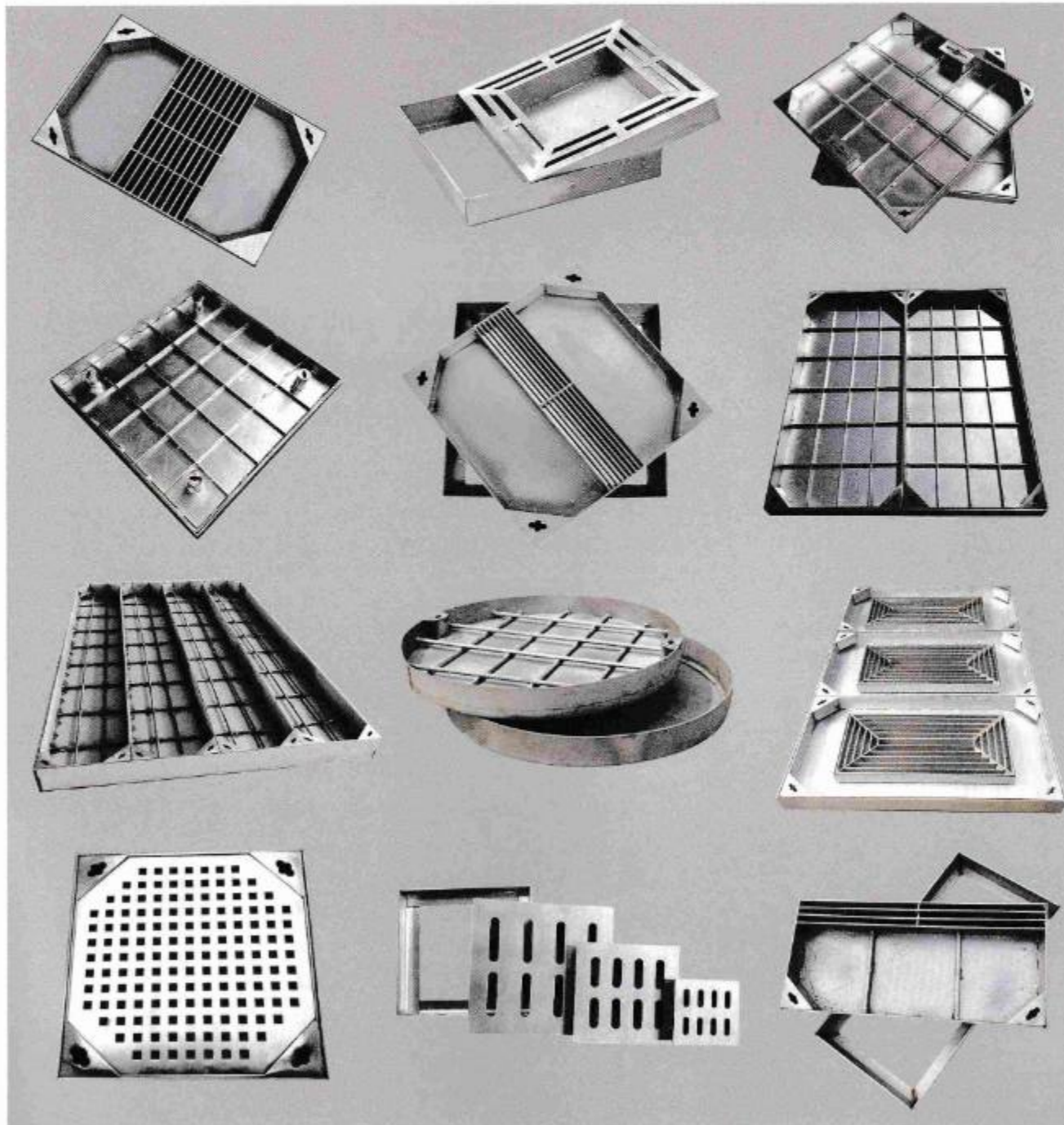

ROOF DRAIN

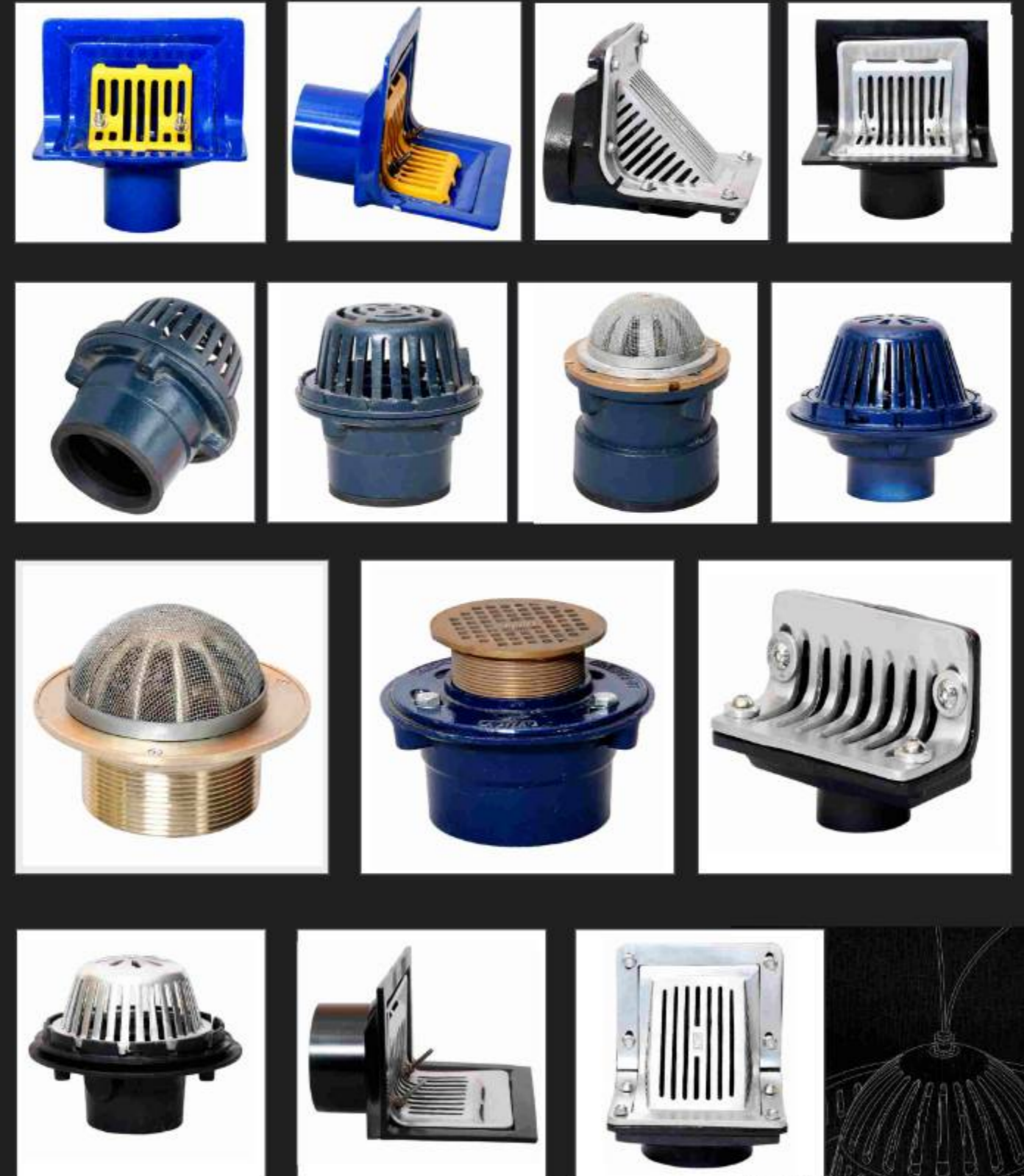

CAST NICKEL BRONZE DOWN SPOUT WITH FLANGE PUSHFIT

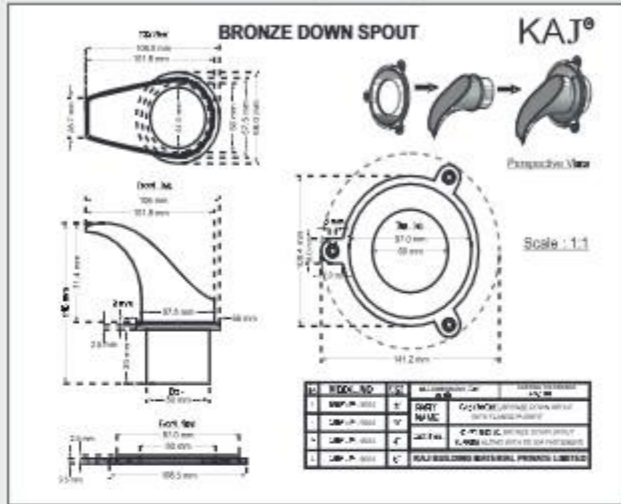

CAST NICKEL BRONZE DOWN SPOUT WITH FLANGE PUSHFIT

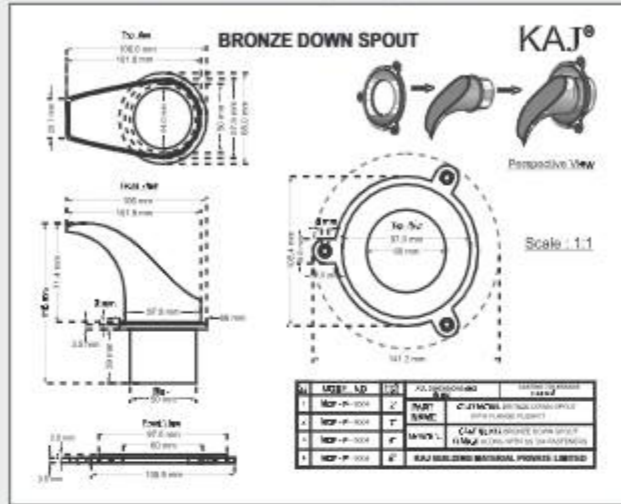

CAST NICKEL BRONZE DOWN SPOUT WITH FLANGE PUSHFIT

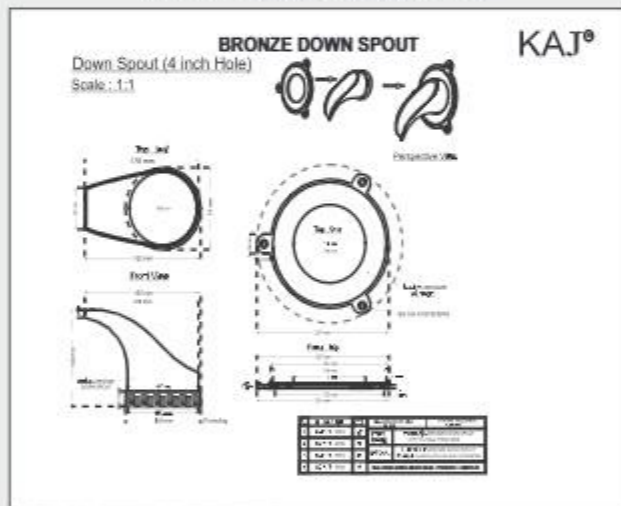

PERA PIT DRAIN

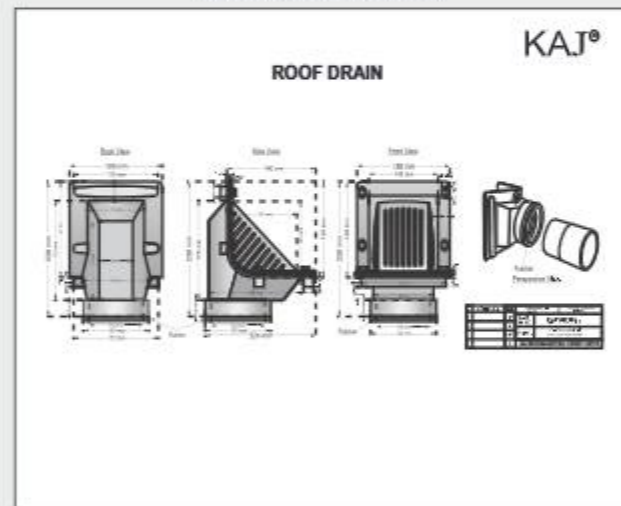

PERA PIT DRAIN

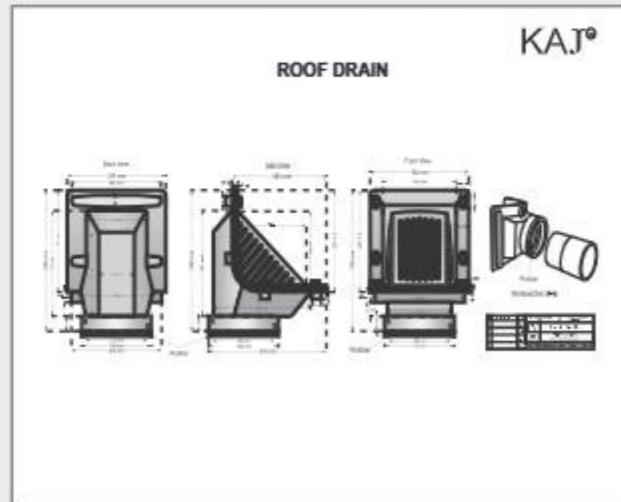

FLOOR DRAIN

CLEAN OUT 100 MM

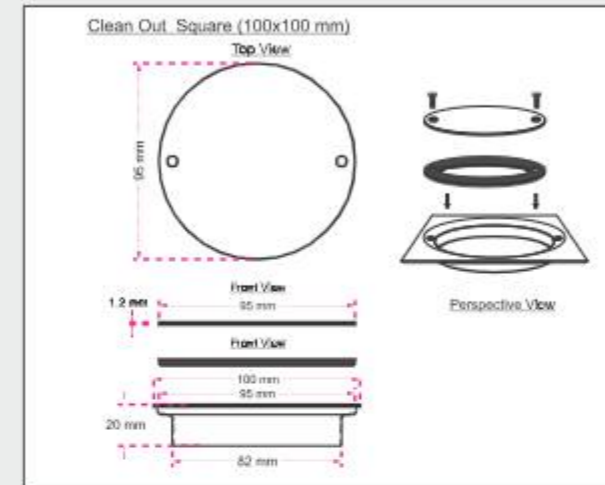

CLEAN OUT 150 MM

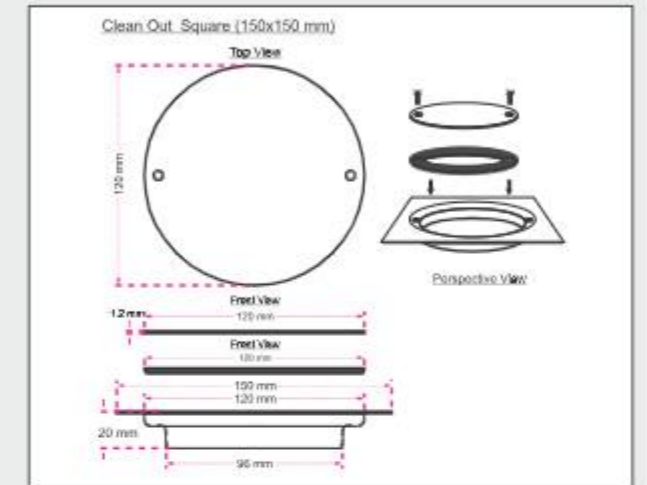

FLOOR DRAIN 100 MM

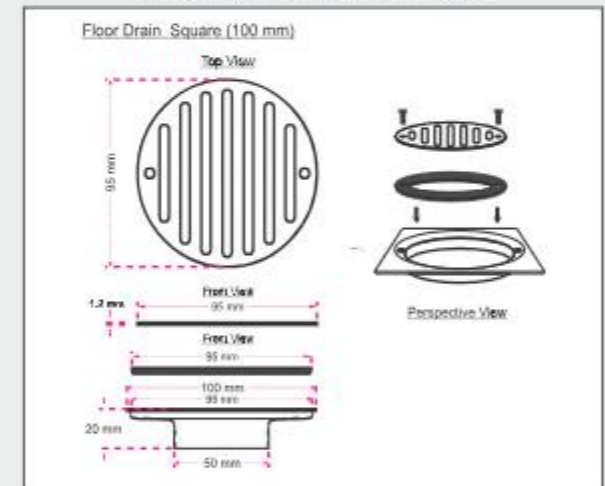

VEN COOL 85 MM

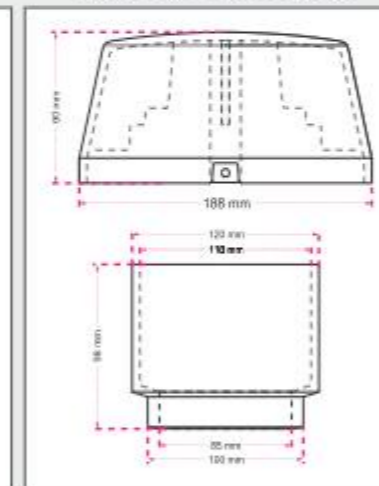

VEN COOL 110 MM

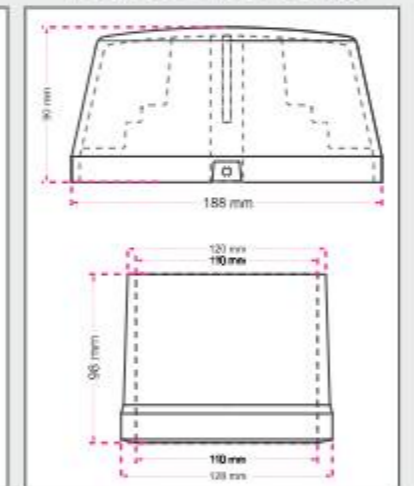

LYNER DRAIN LONG 900X100

Lyner Drain Long

900 X 100 - 85 mm

Scale - 1:1

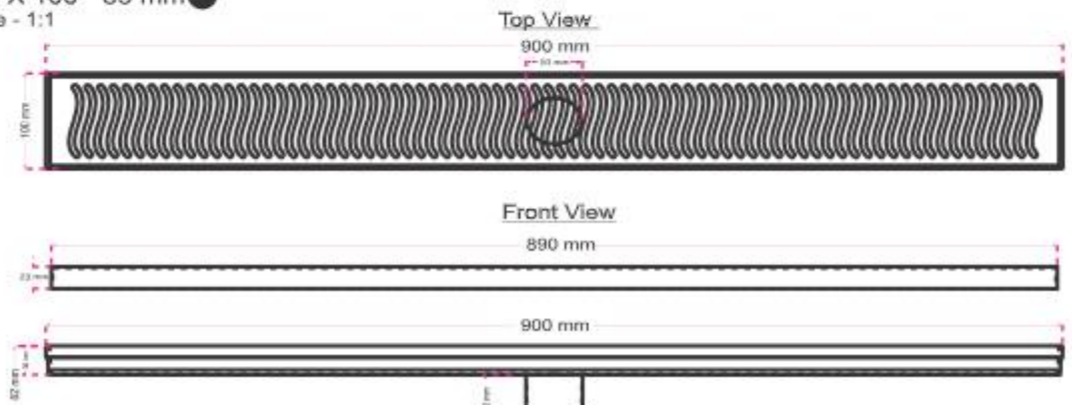

ROOF DRAIN

CAST IRON GULLY TRAP



Product Code	Description	Usage	Dimension	Size	M.R.P
KAJ	FF-8" Square Cast Iron Frame & Grating with 4 SS Screw	Gully Trap Cover / Hotels / Parking / Walkways / Terrace	230mm X 230mm X 24mm (Height)	230 mm x 230 mm 330 mm x 330 mm 450 mm x 450 mm	3050/- 4000/- 5250/-

OTHER SIZE : (a) NGT6002 (CI) 300mm X 300mm X 25mm (without Frame)
(b) NGT6002 (Hingh) 600mm X 600mm X 25mm with hing Lock system & Frame



ADJUSTABLE FLOW DRAIN

Product Code	Description	Usage	Dimension	M.R.P
KAJ	FF-4" (100mm) CI Body with Clamping Collar and 4" Adjustable Nickle Bronze Round Body and Grate	Floor Grating	CI Body Outlet - 100mm Floor Size Inlet - 150mm Outlet Size of Strainer - 100mm Height of Strainer - 40mm Minimum Fixed Size of Strainer - 230mm	7500/-

OTHER SIZE : (a) NAS 4003-150mm x 230mm x 150mm x 105mm x 40mm x 30mm x 290mm

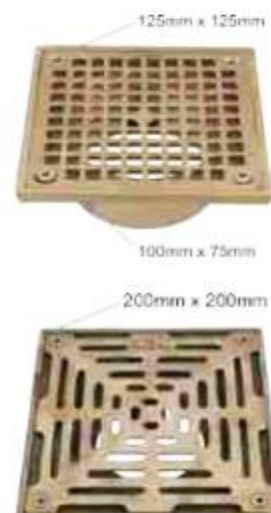

NICKLE BRONZE (STRAINER) / FLOOR DRAIN

Product Code	Description	Usage	Size	M.R.P
KAJ	FF-6" (150mmX-150mm) Cast Bronze Strainer	Floor Drain, Bathroom, Kitchen, Hotels, Hospitals, Common Floor	80 mm x 80 mm x 50 mm 100 mm x 100 mm x 75 mm 125 mm x 125 mm x 100 mm 125 mm x 125 mm x 75 mm 150 mm x 150 mm x 100 mm 200 mm x 200 mm x 100 mm	2500/- 2850/- 3850/- 4050/- 6000/- 12500/-

NOTE : Available in Thread and Push Type Options

ROOF DRAIN

FLOOR DRAIN - FUNNEL TYPE (NICKLE BRONZE)



Product Code	Description	Usage	Dimension	Size	M.R.P
KAJ	NSF9001 FF-4" (100mm) Cast Bronze Strainer with Bronze Funnel & 4 SS Screw with Gasket	Commercial Kitchen/ Ice Equipment/ Hotels/ Hospitals	Outlet - 100mm Floor Size Inlet - 130mm Height of Funnel - 100mm Height of Strainer - 50mm Dia of Funnel - 50mm	125mm x 125mm x 100 mm 125mm x 125mm x 75 mm 150mm x 150mm x 100 mm 200mm x 200 mm x 150 mm	5650/- 5500/- 6800/- 8000/-

NOTE : Available in Round Shape Also



DOWN SPOUT (NICKLE BRONZE)

Product Code	Description	Usage	Dimension	M.R.P
KAJ	RF-4" (100MM) NICKEL Bronze Down Spout (Linished) with Bronze Wall Flange	Roof Rain Water Pipe/ Wall Fitting	Inlet 125 mm Length 140mm	2900/- 3800/- 4850/- 6500/-

OTHER SIZE : Inlet 50mm, 75mm, 150mm, 200mm
SPECIFICATION : Inlet 50mm, 75mm, 150mm, 200mm



ROUND FLOOR DRAIN - LOCK TYPE

Product Code	Description	Usage	Dimension	Size	M.R.P
KAJ	FF-4" Cast Bronze Chrome Plated 'Lock Type' Ring & Grating	Kitchen/ Bathroom/ Hotels/ Hospitals/ Common Floor	110MM (Frame) x 20mm (Height) x 100mm Outlet	100 mm Round 150 mm Round 108 mm Round	1050/- 1450/- 1100/-

OTHER SIZE : 170mm Frame x 20mm Height x 150mm Outlet
OPTION : Also available in cast SS 304

SEAL PLATES



The Unite retrofittable seal plate is manufactured from ductile iron, setting it apart from the competition.

Alternatives, which are often manufactured from GRP, can allow corrosion to form between the plate and frame. In fact, other materials can even accelerate corrosion. Our ductile iron assembly provides the best corrosion resistance, as the covers, frames and seal plates are all made from the same material.

LIFTING KEYS



KEY SMALL



KEY HEAVY



KEY LONG

A lift key, often called a manhole key, is a specialized tool used to safely and effectively remove a manhole cover from its frame. Its primary purpose is to provide a secure handle and leverage point to break the seal and lift the heavy cover, allowing access to the underground chamber, utilities, or sewer systems below.

How the Lift Key Works

The manhole cover typically has one or two designated keyholes (or keyways).

1. Insertion: The lift key is inserted into these keyholes. Depending on the design, some keys simply hook into a recess, while others, like screw-in keys, are threaded to securely fasten into the cover.
2. Lifting: Once secured, the key provides a T-handle or leverage point for workers to lift the heavy cast iron or composite cover without having to use hands on the often dirty or sealed edges. This prevents injury and ensures the cover is replaced correctly.

LIGHT DUTY MANHOLE COVER RANGE

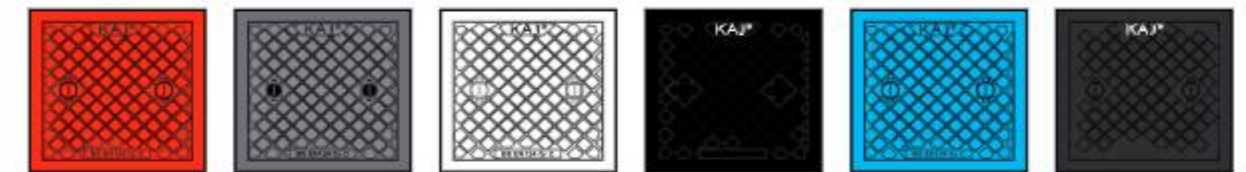

MULTI COLOUR RANGE



Custom Logo Cover



Grate Option



ADA Compliant



Hinged Option



Special Lettered Cover

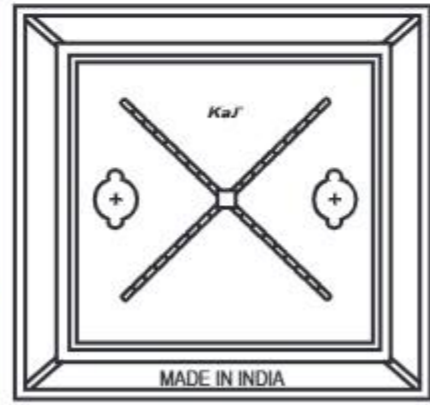
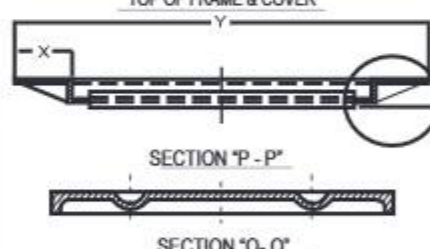
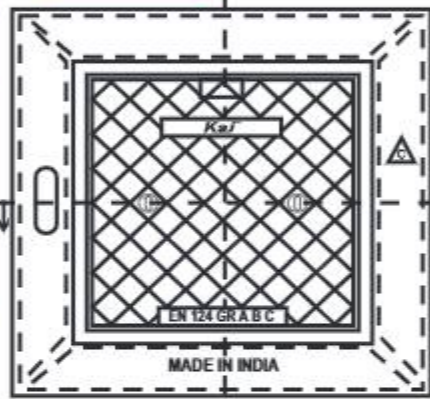

Pedestrian Use
 Anti Skid
 Non rocking
 All weather poof



GROSS PLATED WEIGHT :
 2.5 TONNE
 For Pedestrian use.

GROSS PLATED WEIGHT :
 WEIGHT 5 TONNE
 Will support a slow moving
 wheel load of 1.25 tonnes.
 Recommended for domestics
 driveway applications.



Light Duty



Light Duty

OVER BASE	SET WT
200 X 200	2 KG
250 X 250	2.5 KG
300 X 300	3.5 KG
300 X 300 MEDIUM	6.5 KG
300 X 300 HEAVY	10.5 KG
350 X 350	4.5 KG
400 X 400 LIGHT	6.5 KG
400 X 400 MEDIUM	8.5 KG
400 X 400 HEAVY	12.5 KG
450 X 450	8 KG
500 X 500 LIGHT	10 KG
500 X 500 MEDIUM	15 KG
500 X 500 HEAVY	30 KG
600 X 600 LIGHT	15 KG
600 X 600 MEDIUM	20 KG
600 X 600 HEAVY	30 KG
700 X 700 LIGHT	22 KG
700 X 700 MEDIUM	32 KG
700 X 700 HEAVY	42 KG
800 X 800 LIGHT	45 KG
800 X 800 MEDIUM	55 KG
800 X 800 HEAVY	70 KG
900 X 900 LIGHT	75 KG
900 X 900 MEDIUM	85 KG
900 X 900 HEAVY	105 KG
1000 X 1000	120 KG

FOOT STEP

DUCTILE IRON FOOT STEP



CAST IRON FOOT STEP

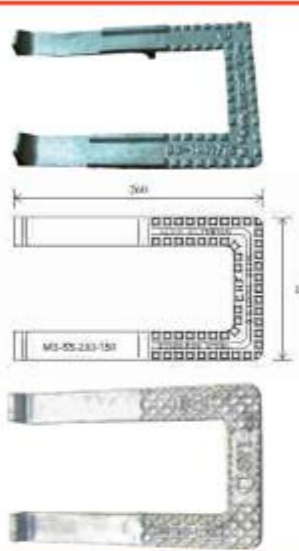

MILD STEEL FORGED FOOT STEP



PVC Steel Reinforce Foot Steps

Step Safe is a uniquely designed manhole safety step (also known as footrest) made from polypropylene and steel composite. It offers superior resistance to corrosive environments characteristic of sanitary sewers. In addition, the unique slip resistant design and bright colours provide added safety to the cleaning personnel.

Step Safe suitable for sewerline manholes, overhead water tanks and service shafts of multistory building.

Step Safe is available in five different sizes/shapes/colour.

Specifications:
 Polypropylene - 3mm thick copolymer polypropylene conforming to ASTM D-4101/IS 1786
 Steel - 10/16 mm diameter steel bar conforming to IS 1786
 Load Requirement - Easily exceeds 225 kg as per IS-5455
 Surface Finish - 2mm tread on top surface by ribbing or chequering.
 Application - Sewer Line Manhole over head tank.



Specifications: Polypropylene element conforming ASTM D-4101, Injection moulded over, reinforced steel bar Indian Standard Specification 1786 grade FE-415 steel (Options: 12 mm dia steel or 16 mm dia galvanised steel) meets load requirements of 225 kgs. As per Indian Specification - 5455.

Installation : Step can be cast - in place. **Kaj Safe Step** can resist capacity over 500 kgs approx.

Longevity : Polypropylene is known for its high resistance capacity for all types of corrosive environments normally found in sewers.

Safety Features : This step with Anti Skid Design, High Stability, Fire & Rust Proof.

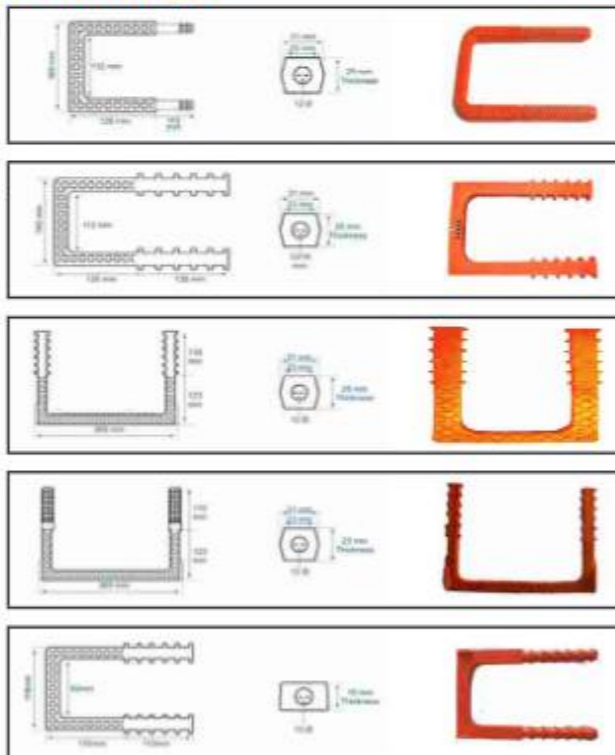

GLOSSARY

I. Material & Manufacturing

| Term | Definition |

| **Ductile Iron (DI)** | A type of cast iron (also known as Spheroidal Graphite Iron or SG Iron) where the graphite in the microstructure is in a spherical (nodular) form, rather than flakes. This structure imparts high strength, ductility, and impact resistance, making it superior to traditional Grey Cast Iron for heavy loads.

| **Nodularization** | The process of adding an alloy (typically magnesium) to molten cast iron to change the shape of the graphite from brittle flakes into resilient spheres (nodules), thus creating ductile iron.
Grey Cast Iron (GCI) | The traditional material for manhole covers, where graphite is in flake form. It is cheaper but more brittle and has lower impact resistance than ductile iron.

| **Tensile Strength** | The maximum stress a ductile iron cover can endure while being stretched or pulled before breaking. Ductile iron has significantly higher tensile strength than grey cast iron.

| **Casting** | The manufacturing process where molten ductile iron is poured into a mold (typically sand molds) that is shaped like the cover and frame, and then allowed to solidify.

| **Bitumen Coating** | A standard protective coating, often black, applied to the cover and frame to provide initial resistance against corrosion (rust) and environmental factors.

II. Components & Design

| Term | Definition |

| **Cover (Lid)** | The removable plate, made of ductile iron, that closes the manhole opening. It typically features an anti-slip surface pattern.

| **Frame (or Seating)** | The fixed metal ring, also made of ductile iron, that is embedded in the pavement or concrete and provides a stable, load-bearing seat for the cover.

| **Clear Opening (CO)** | The nominal, unobstructed internal diameter or dimensions of the frame aperture. This is the critical measurement that defines the access size to the underground chamber.

| **Overall Dimensions** | The external measurements (length, width, or diameter) of the complete cover and frame unit. |

| **Anti-Slip Surface** | A raised pattern (e.g., checker plate, diamond pattern) cast onto the top surface of the cover to increase traction and prevent pedestrians and vehicle tires from slipping. |

| **Keyway / Keyhole** | A slot or hole on the cover surface designed to insert specialized lifting keys (or hooks) for safe and easy removal of the cover for maintenance access. |

| **Sealing (Single/Double)** | A design feature (often a tongue-and-groove or labyrinth system) between the cover and frame that helps prevent the egress of odors/gases and the ingress of water or dirt. |

| **Hinge** | A pivot mechanism that connects the cover to the frame, allowing the cover to be opened without full removal. This is a common anti-theft feature and enhances worker safety. |

| **Locking System** | A mechanism (e.g., bolts, turnbuckles, or proprietary locking systems) used to secure the cover to the frame, preventing unauthorized access or accidental displacement by traffic. |

| **Gully Grate** | A specific type of casting designed for surface water drainage (storm drains), typically having an open bar or grating pattern instead of a solid cover. |

III. Standards & Classification

| Term | Definition |

| **BS EN 124** | The primary European standard that specifies the general principles for the construction, design requirements, type testing, marking, and quality control of covers and frames for gullies and manholes. |

GLOSSARY

| Load Classification | A system defined by standards (like BS EN 124) that categorizes manhole covers based on the maximum test force they can withstand. This determines the appropriate area of use. |

| A15 | Load Class (Group 1): Covers tested to a 15 kN (approx. 1.5 tonne) load. Used for areas only accessible to pedestrians and cyclists (e.g., sidewalks, verges). |

| B125 | Load Class (Group 2): Covers tested to a 125 kN (approx. 12.5 tonne) load. Used for footways, pedestrian areas, and car parks/driveways accessible to light vehicles. |

| C250 | Load Class (Group 3): Covers tested to a 250 kN (approx. 25 tonne) load. Used for edge areas of roads, kerbside channels, and parking areas. |

| D400 | Load Class (Group 4): Covers tested to a 400 kN (approx. 40 tonne) load. The most common class for carriageways, hard shoulders, and all traffic areas.

| E600 | Load Class (Group 5): Covers tested to a 600 kN (approx. 60 tonne) load. Used for areas subject to high-wheel loads, such as docks, industrial estates, and loading areas. |

| F900 | Load Class (Group 6): Covers tested to a 900 kN (approx. 90 tonne) load. Used for areas subject to particularly high-wheel loads, such as airports and cargo terminals. |

| kN (KiloNewton) | The unit of force used for load classification, where 1 kN is approximately the force exerted by a mass of 102kg under Earth's gravity. |

| Solid Top Manhole Cover | A basic manhole cover with a plain, non-perforated top surface, typically featuring a non-slip pattern (like chequer plate). It is designed to be fully visible and flush with the surrounding surface, used to seal an access point against dirt, debris, and odor ingress. |

| Recessed Top Manhole Cover | A manhole cover designed with a metal tray or recess in the lid, allowing the top to be filled with the surrounding material (e.g., paving blocks, tarmac, screed, or concrete). The purpose is to hide the cover, making it visually blend into the adjacent surface, commonly used in

residential areas, driveways, and pedestrian zones. |

| Gully Grating | A perforated or slotted cover placed over a gully pot (a chamber that collects surface water and traps silt/debris before it enters the main drainage system). The grating is designed to allow water to drain rapidly while blocking large objects from entering the gully. |

| Kerb Grating | A type of gully grating specifically designed to be integrated into the vertical face of a road kerb (curb). It allows surface water runoff from the road to enter the drainage system from the side, often used in conjunction with a traditional gully grating in the road. |

| Channel Grating | A perforated or slotted cover designed to fit over a linear or trench drain (a shallow channel). It spans the width of the trench, allowing continuous collection of surface water across a length, commonly seen in car parks, industrial floors, and pedestrian walkways. |

| Water Conveying Systems | The integrated network of structures and conduits used for the collection and transport of water, wastewater, or stormwater runoff from one location to another. This system includes both natural elements (swales, streams) and constructed elements (pipes, canals, aqueducts, culverts, channels, and associated access points like manholes and gullies). |

| Clear Opening (CO) | The nominal unobstructed dimension of the access hole or aperture (the internal opening) into which the cover or grating fits. This measurement is critical for determining the correct size of the manhole cover or frame. |

| Safe Working Load (SWL) | A term, generally superseded by load classification standards like EN 124, that indicates the maximum load (in tonnes or kiloNewtons, kN) an installed cover or grating is designed to safely withstand. |

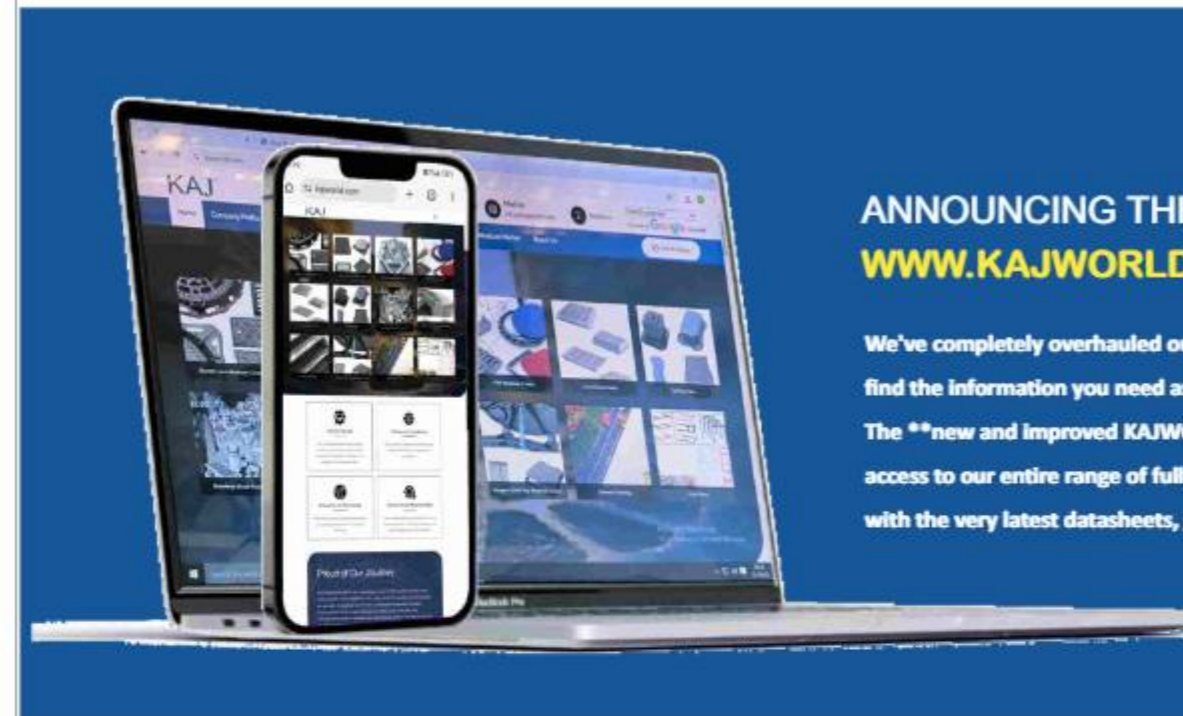

ANNOUNCING THE REDESIGNED WWW.KAJWORLD.COM

We've completely overhauled our website to ensure you can find the information you need as quickly and easily as possible. The ****new and improved KAJWORLD.COM**** now offers instant access to our entire range of fully searchable products, along with the very latest datasheets, guides, and videos.

Key New Features

Up-to-Date Product Data

The new layout makes it simple to navigate and search for products. You'll find current, essential information, including:

Datasheets

Product images and dimensions

Guides and videos

Enhanced Technical Support

Building on our strong reputation in the civil engineering field, our revamped Technical Centre provides extensive support. It features a wealth of articles, blogs, documents (Doqs), and "how-to" guides, ensuring expert help is always available.

WWW.KAJWORLD.COM



Scan here to visit.

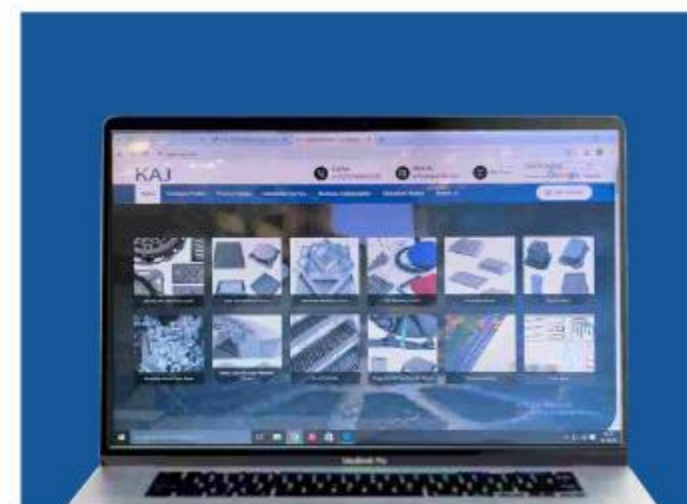

KOLKATA Address : 74A, CHARU AVENUE, KOLKATA - 700 033
UAE Address : Plot Number : 619-0 Building Name :
ABRAJ Center, Naif Street - Dubai

Website : kajworld.com
Email : info@kajworld.com

+971 52 831 3848 DUBAI
+971 52 186 7876 DUBAI
+91 9088866000 INDIA
+91 9830060210 INDIA